

MODEL : AMS-220C

List No : 0688-02

PARTS LIST

Published:02/15/2019

CONTENTS

FRAME & MISCELLANEOUS COVER COMPONENTS (1)	1
FRAME & MISCELLANEOUS COVER COMPONENTS (2)	5
FRAME & MISCELLANEOUS COVER COMPONENTS (3)	7
MAIN SHAFT & NEEDLE BAR COMPONENTS	9
PRESSER MECHANISM COMPONENTS	13
SHUTTLE DRIVER SHAFT COMPONENTS	17
WIPER MECHANISM COMPONENTS	21
TENSION RELEASE & THREAD TRIMMER MECHANISM COMPONENTS	23
X-Y COMPONENTS (1)	27
X-Y COMPONENTS (2)	29
CLOTH FEED MECHANISM COMPONENTS	31
LUBRICATION COMPONENTS	35
SENSOR COMPONENTS	39
PNEUMATIC COMPONENTS	41
TABLE COMPONENTS	43
THREAD STAND COMPONENTS	47
CONTROL BOX COMPONENTS	49
OPERATION BOX COMPONENTS	51
CIRCUIT BOARD COMPONENTS	53
POWER SUPPLY & CORD COMPONENTS	55
PEDAL & ELECTRIC EQUIPMENT ACCESSORIE PART COMPONENTS	57
ACCESSORIE PART COMPONENTS	59
OPTIONAL COMPONENTS	61
HOW TO MAKE USE OF THIS PARTS LIST	63

FRAME & MISCELLANEOUS COVER COMPONENTS (1)

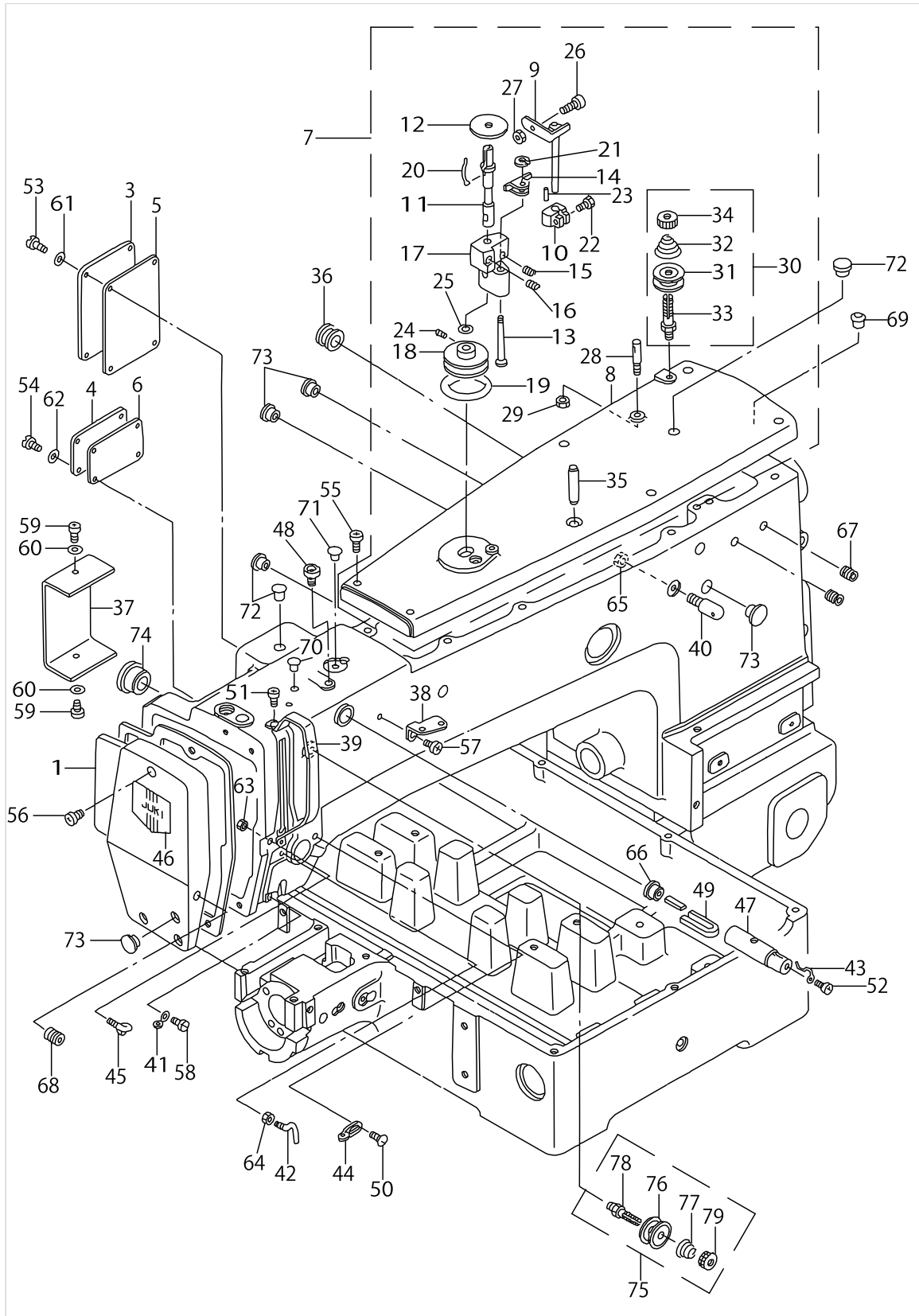

FRAME & MISCELLANEOUS COVER COMPONENTS (1)

No.	Parts No.	Parts name	Remarks	Level	Cons	Qty
1	B110522000A	FACE PLATE				1
2	B1117220000	FACE PLATE GASKET				1
3	B112222000B	COVER (A)				1
4	B112322000B	COVER (B)				1
5	B1124220000	GASKET A				1
6	B1125220000	GASKET B				1
7	B11042200AB	TOP COVER ASM.				1
8	B110422000B	TOP COVER		*		1
9	B32012100A0	STOP LATCH ASM.		*		1
10	B3203210000	CAM		*		1
11	B3204210000	SPINDLE		*		1
12	B3205210000	CUSHION		*		1
13	B3206210000	SCREW STUD		*		1
14	B3207210000	TRIP LATCH		*		1
15	B3208210000	SPRING A		*		1
16	B3209210000	SPRING B		*		1
17	B3210210000	BOBBIN WINDER BASE		*		1
18	B3211210000	BOBBIN WINDER WHEEL		*		1
19	B3212210000	FRICITION WHEEL		*		1
20	B3212761000	LATCH SPRING		*		1
21	D2430555B00	SNAP RING		*		1
22	SS9111020TP	SCREW 11/64-40 L=10		*		1
23	PS0150065KP	SPRING PIN 1.5X6		*		1
24	SS8110520TP	SCREW 11/64-40 L= 4.5		*		2
25	WP0651056SH	WASHER 6.5X11X1		*		1
26	B3208280000	BOBBIN WINDER ADJUSTING SCREW		*		1
27	NS6110530SP	NUT 11/64-40		*		1
28	10007003	THREAD GUIDE PIN		*		1
29	NS6110310SP	NUT 11/64-40		*		1
30	B11152320A0	FIRST THREAD TENSION ASM.		*		1
31	B3126012000	THREAD TENSION DISK		*		2
32	B1115232000	FIRST THREAD TENSION SPRING		*		1
33	B3123352000	THREAD TENSION ROD		*		1
34	B3125012000	THREAD TENSION NUT		*		1
35	PS0800302KH	SPRING PIN 8X30		*		1
36	B1126210000	WIRE BUSHING				1
37	B112821000B	SWITCH COVER				1
38	B1111232000	THREAD GUIDE PLATE				1
39	13816608	BALANCE COVER				1
40	B1123280000	FIRST THREAD GUIDE				1
41	B1124280000	ARM THREAD GUIDE B				1
42	B1125280000	L-SHAPED THREAD GUIDE A				1
43	B1127280000	SILICON OIL THREAD GUIDE				1
44	B1126552000	ARM THREAD GUIDE A				1
45	B3114771000	THREAD GUIDE				1
46	B1178191000	FACE PLATE DRESSING TABLE				1
47	13501309	SILICON OIL PIPE				1

FRAME & MISCELLANEOUS COVER COMPONENTS (1)

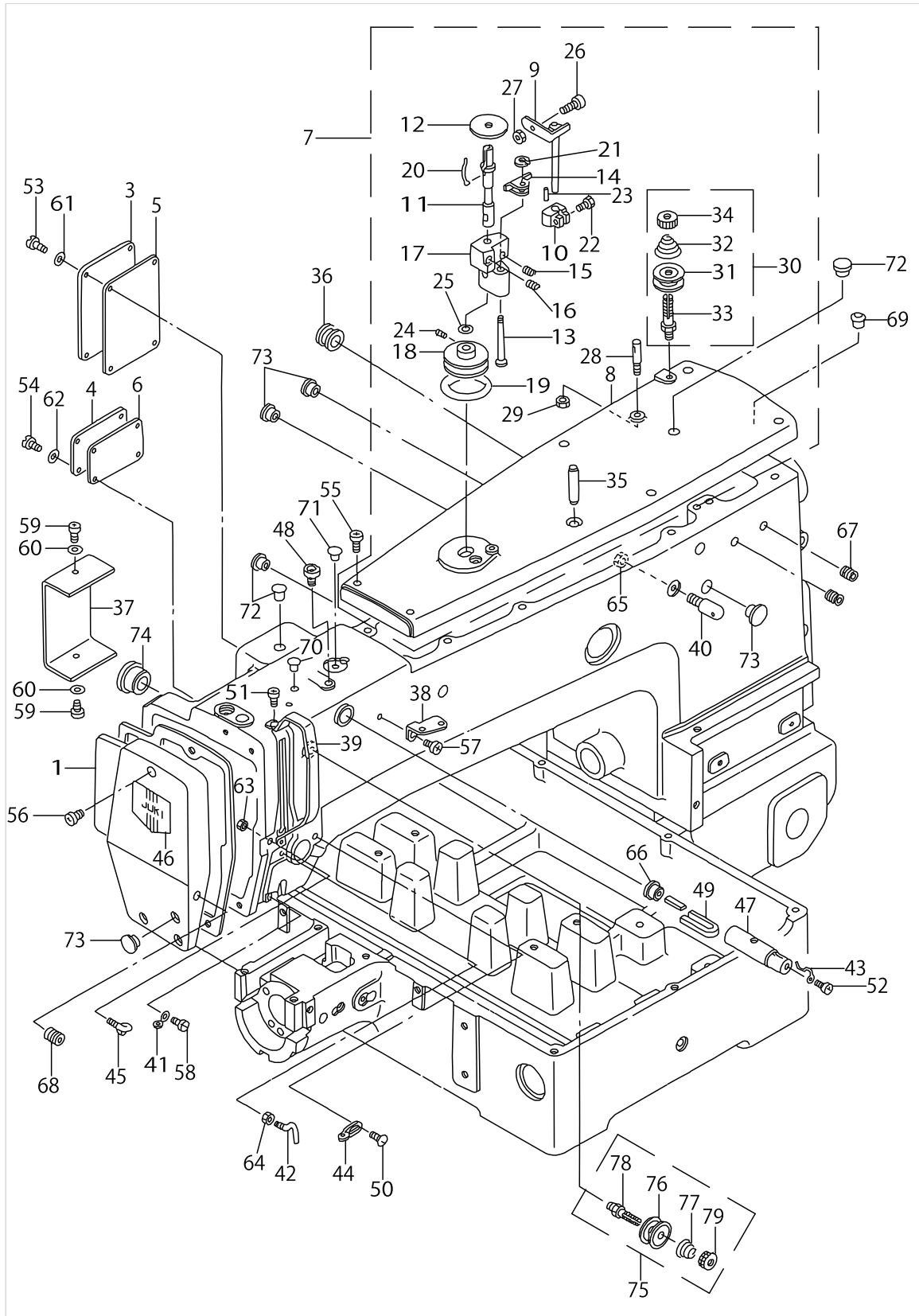

FRAME & MISCELLANEOUS COVER COMPONENTS (1)

No.	Parts No.	Parts name	Remarks	Level	Cons	Qty
48	13501408	SILICON OIL POURING HOLE				1
49	13501705	SILICON OIL FELT				1
50	SS3090610SP	SCREW 9/64-40 L=6				1
51	SS4090715SP	SCREW 9/64-40 L=7				2
52	SS4110515SP	SCREW 11/64-40 L=5				1
53	SS4110815SP	SCREW 11/64-40 L=8				4
54	SS4110815SP	SCREW 11/64-40 L=8				4
55	SS4111015SP	SCREW 11/64-40 L=10				6
56	SS4111015SP	SCREW 11/64-40 L=10				3
57	SS4150715SP	SCREW 15/64-28 L=7				1
58	SS7110840SP	SCREW 11/64-40 L=7.8				1
59	SM4040601SC	SCREW M4X0.7 L=6				2
60	WP0430801SC	WASHER M4				2
61	WP0450000SD	WASHER 4.5X8X0.5				4
62	WP0450000SD	WASHER 4.5X8X0.5				4
63	NS6090310SP	NUT 9/64-40				1
64	NS6090310SP	NUT 9/64-40				1
65	NS6150310SP	NUT 15/64-28				1
66	TA1050504R0	RUBBER PLUG				1
67	SS8110560SP	SCREW 11/64-40 L=4.5				2
68	SS8090410SP	SCREW 9/64-40 L= 3.5				1
69	B1405012000	CAP				1
70	TA0750704R0	RUBBER PLUG				1
71	TA0850604R0	RUBBER PLUG				1
72	TA1050504R0	RUBBER PLUG				3
73	TA1250406R0	RUBBER PLUG				4
74	TA2100904R0	RUBBER PLUG				1
75	B11152320A0	FIRST THREAD TENSION ASM.				1
76	B3126012000	THREAD TENSION DISK		*		2
77	B1115232000	FIRST THREAD TENSION SPRING		*		1
78	B3123352000	THREAD TENSION ROD		*		1
79	B3125012000	THREAD TENSION NUT		*		1

FRAME & MISCELLANEOUS COVER COMPONENTS (2)

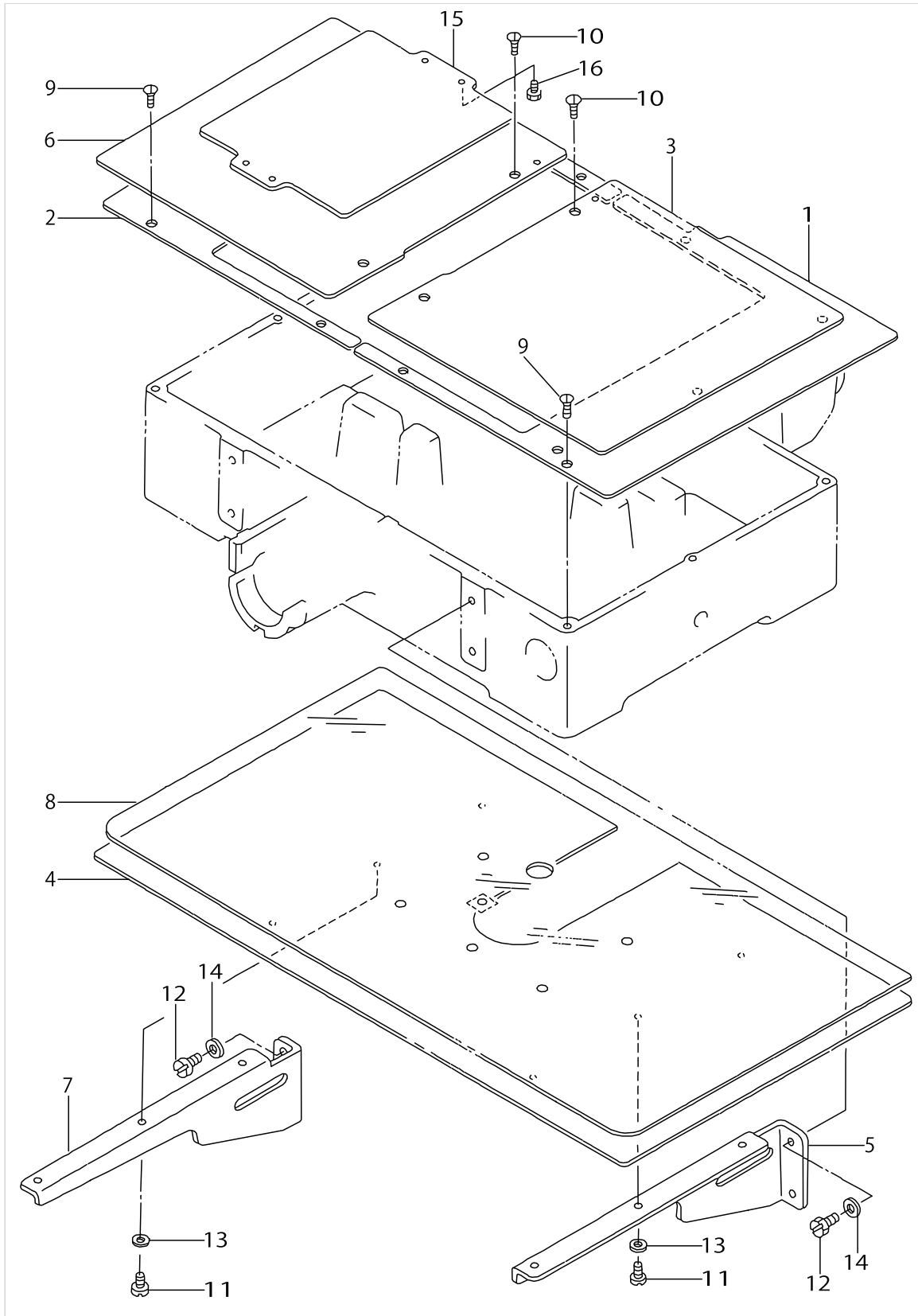

FRAME & MISCELLANEOUS COVER COMPONENTS (2)

No.	Parts No.	Parts name	Remarks	Level	Cons	Qty
1	B1108220000	RIGHT COVER				1
2	B1109220000	LEFT COVER				1
3	B111022000A	AUXILIARY COVER, RIGHT				1
4	B1112220000	NEEDLE PLATE AUXILIARY COVER				1
5	B1113220000	AUXILIARY COVER SUPPORT, RIGHT				1
6	B111822000A	AUXILIARY COVER, LEFT				1
7	B1121220000	AUXILIARY COVER SUPPORT, LEFT				1
8	B1170220000	AUXILIARY COVER SHEET				1
9	SS1110840SP	SCREW 11/64-40 L=8				10
10	SS1110840SP	SCREW 11/64-40 L=8				4
11	SS6110610TP	SCREW 11/64-40 L=6				6
12	SS9151160CP	SCREW 15/64-28 L=10.5				4
13	WP0520656SA	WASHER 5.2X9.5X0.6				6
14	WP0621016SD	WASHER 6.2X13X1				4
15	B1502220000	PRESSER PLATE				1
16	SS9151120CP	SCREW 15/64-28 L=11				4

FRAME & MISCELLANEOUS COVER COMPONENTS (3)

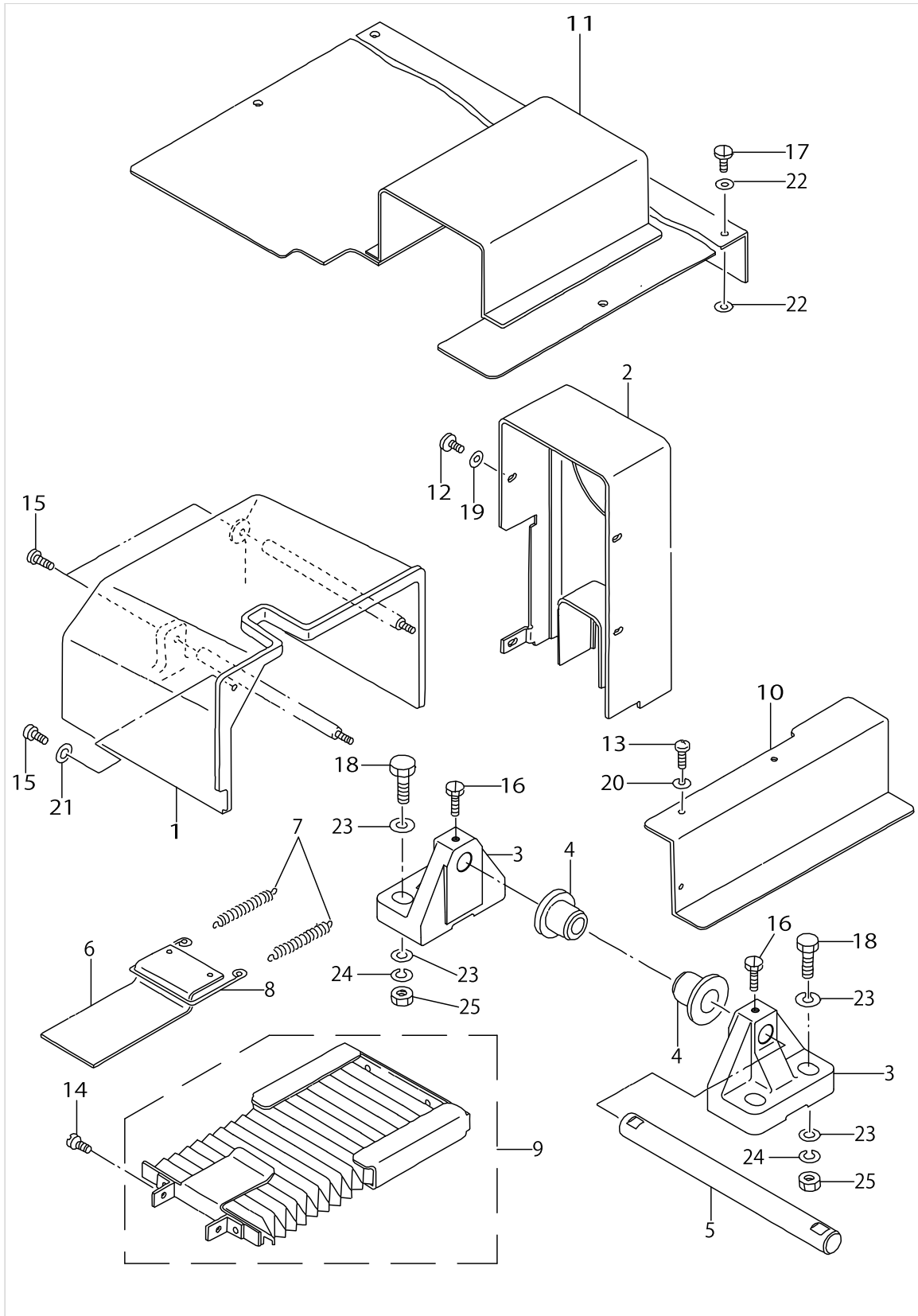

FRAME & MISCELLANEOUS COVER COMPONENTS (3)

No.	Parts No.	Parts name	Remarks	Level	Cons	Qty
1	B110622000B	SIDE COVER				1
2	B110722000A	BELT COVER				1
3	B1111220000A	BED HINGE				2
4	B1115220000	RUBBER PAD A				2
5	B1120220000	BED HINGE SHAFT				1
6	B1150220000	MOVEMENT COVER A				1
7	B1151220000	TENSION SPRING				2
8	B1152220000	TENSION WIRE				1
9	B11532200A0	MOVEMENT COVER B ASM.				1
10	B115822000B	Y SENSOR COVER				1
11	B1159220A00	TABLE REAR COVER				1
12	SS4110715SP	SCREW 11/64-40 L=7				4
13	SS4110715SP	SCREW 11/64-40 L=7				3
14	SS4110715SP	SCREW 11/64-40 L=7				2
15	SS4111015SP	SCREW 11/64-40 L=10				3
16	SS9151240SN	SCREW 15/64-28 L=11.5				2
17	SM5051400SC	SCREW M5 L=14				4
18	SM9124503SB	SCREW M12 L=45				4
19	WP0450801SD	WASHER 4.5X10.0X0.8				4
20	WP0450801SD	WASHER 4.5X10.0X0.8				4
21	WP0450801SD	WASHER 4.5X10.0X0.8				1
22	WP0841601SC	WASHER 8.4X17.4X1.6				8
23	WP1302501SE	WASHER M12				8
24	WS1253010KN	SPRING WASHER 12.5X21.5X3				4
25	NM6120011SF	NUT M12				4

MAIN SHAFT & NEEDLE BAR COMPONENTS

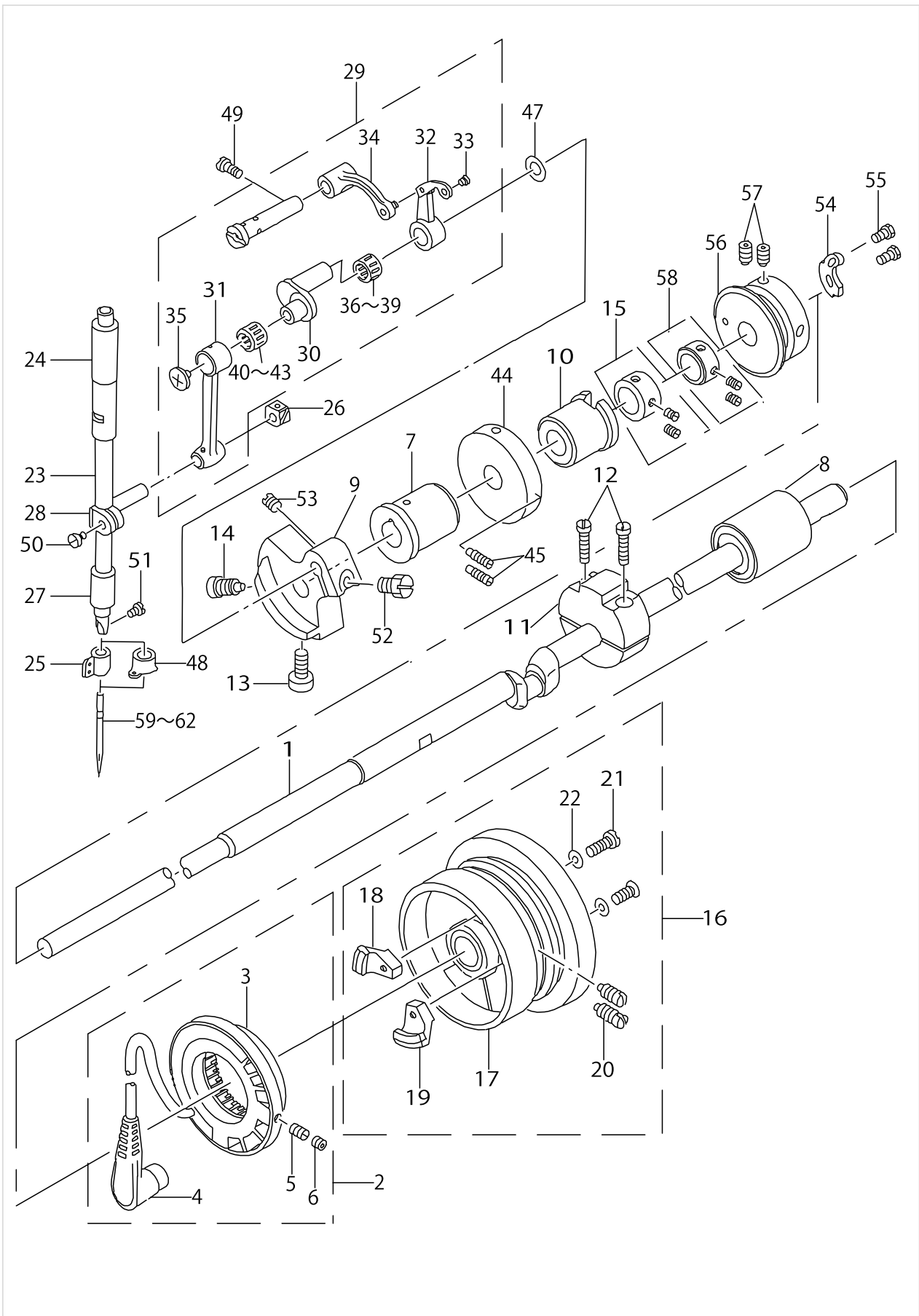

MAIN SHAFT & NEEDLE BAR COMPONENTS

No.	Parts No.	Parts name	Remarks	Level	Cons	Qty
1	B1201220000	MAIN SHAFT				1
2	B12092200A0	GENERATOR STATOR ASM.				1
3	M40051100A0	STATOR ASM.		*		1
4	B12102200A0	SYNCHRONIZE BOARD		*		1
5	SS8111010TP	SCREW 11/64-40 L=9.5		*		2
6	SS8110422TP	SCREW 11/64-40 L=4		*		2
7	B1202210000	BUSHING, FRONT				1
8	B12042100A0	BUSHING, REAR				1
9	B1206210000	COUNTERWEIGHT				1
10	B35142100A0	OIL WICK ASM.				1
11	B1207205000	CRANK BALANCER				1
12	SS6122510SP	SCREW 3/16-28 L=25				2
13	SS6151412TP	SCREW 15/64-28 L=14				1
14	SS6681712TP	SCREW 9/32-28 L=16.5				1
15	CS147121ESH	THRUST COLLAR ASM.D=14.72 W=12				1
16	B12052100BA	HAND WHEEL ASM.				1
17	B12052100AA	HAND WHEEL ASM.		*		1
18	M40071100AB	MAGNET FITTING BASE B ASM.		*		1
19	B12082100A0	SOLENOID INSTALLING PLATE ASM.		*		1
20	SS8151550SP	SCREW 15/64-28 L=15		*		2
21	SS6111210SP	SCREW 11/64-40 L=12		*		2
22	WP0450801SD	WASHER 4.5X10.0X0.8		*		2
23	B1401210000	NEEDLE BAR				1
24	B1402280000	NEEDLE ROD METAL				1
25	B1405210000	THREAD GUIDE A	FOR 220CSS-5000			1
26	B1414232000	SQUARE BLOCK				1
27	B1403280000	NEEDLE ROD LOWER METAL				1
28	B14115520A0	NEEDLE ROD HOLDER ASM.				1
29	B19012800B0	LINK BALANCE ASM.				1
30	B1203280000	NEEDLE ROD CRANK		*		1
31	B1404280000	NEEDLE BAR CRANK ROD		*		1
32	B1901280000	THREAD TAKE-UP LEVER		*		1
33	B1902280000	THREAD HANDLING AREA BUSH		*		1
34	B1903280000	THREAD TAKE-UP CRANK		*		1
35	B1903552000	LEFT SCREW		*		1
36	B1905541A00	NEEDLE BEARING	SELECTIVE PART	*		1
37	B1905541B00	NEEDLE BEARING	SELECTIVE PART	*		1
38	B1905541C00	NEEDLE BEARING	SELECTIVE PART	*		1
39	B1905541D00	NEEDLE BEARING	SELECTIVE PART	*		1
40	B1411804A00	BEARING (A)	SELECTIVE PART	*		1
41	B1411804B00	NEEDLE DRIVING LEVER BEARING B	SELECTIVE PART	*		1
42	B1411804C00	NEEDLE DRIVING LEVER BEARING C	SELECTIVE PART	*		1
43	B1411804D00	BEARING (D)	SELECTIVE PART	*		1
44	B3213205000	BOBBIN WINDER DRIVING WHEEL				1
45	SS8111610SP	SCREW 11/64-40 L=15.5				2
46	B1904280000	BALANCE CRANK PIN				1
47	B1223771000	NEEDLE ROD CRANK WASHER				1

MAIN SHAFT & NEEDLE BAR COMPONENTS

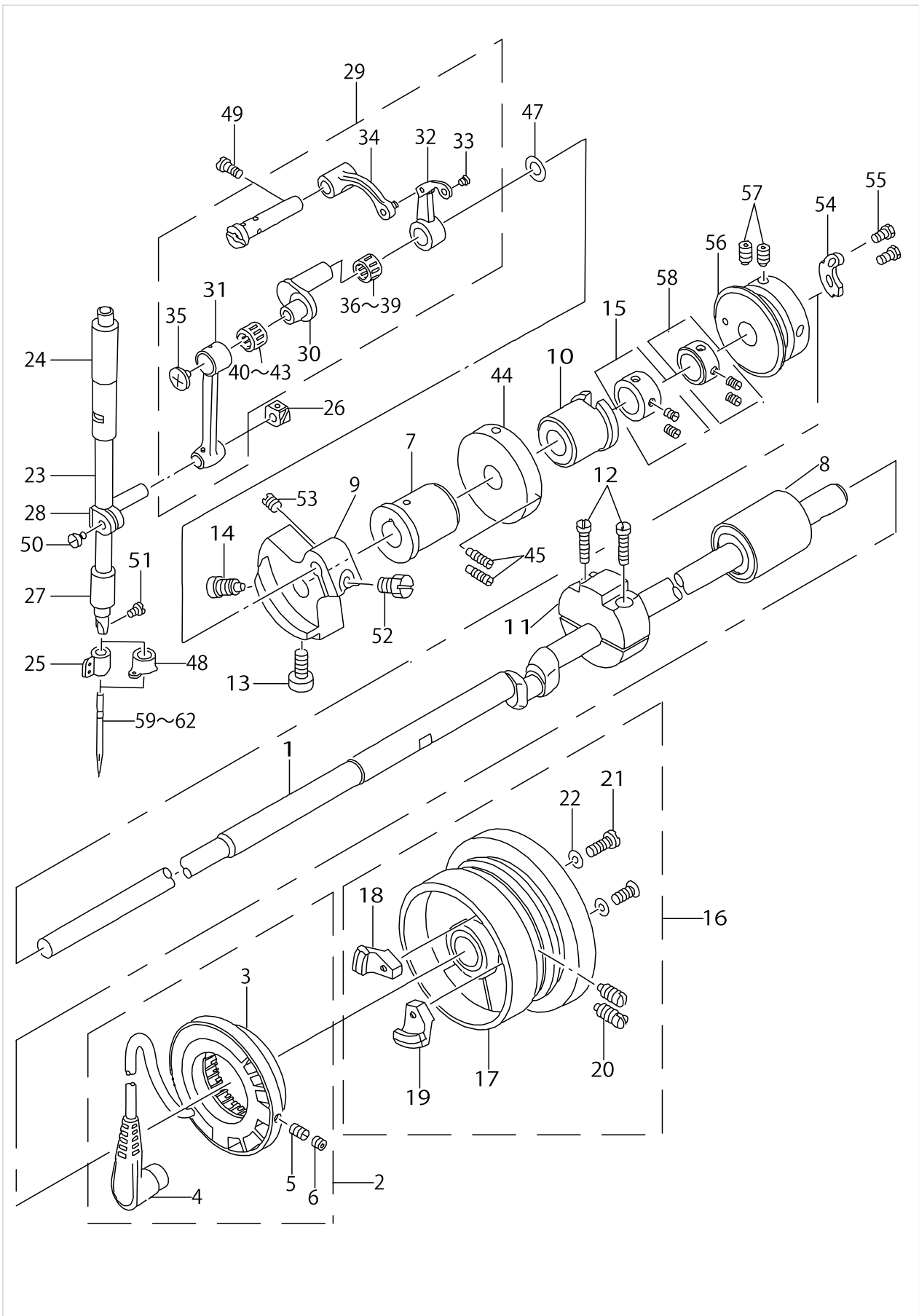

MAIN SHAFT & NEEDLE BAR COMPONENTS

No.	Parts No.	Parts name	Remarks	Level	Cons	Qty
48	B1406210000	THREAD GUIDE	FOR 220CHS-5000			1
49	SS7151120SP	SCREW 15/64-28 L=11				1
50	SS6090670TP	SCREW 9/64-40 L=6				1
51	SS7080510TP	SCREW 1/8-44 L=4.5				1
52	SS9661230CP	SCREW 1/4-40 L=12				1
53	SS8660610TP	SCREW 1/4-40 L=6				1
54	B2312220000	TENSION RELEASE NOTCH				1
55	SS9090833TP	SCREW				2
56	B2401205000	THREAD TRIMMER CAM				1
57	SS8661012TP	SCREW				2
58	CS1470710SH	THRUST COLLAR ASM. D=14.72 W=7				1
59	MDP500B1400	NEEDLE DPX5 #14	FOR 220CSS-5000(EXCEPT JE)			1
60	MC200501000	NEEDLE #100	FOR 220CSS-5000(FOR JE)			1
61	MDP170B1800	NEEDLE DPX17 #18	FOR 220CHS-5000(EXCEPT JE)			1
62	MC372001100	NEEDLE 135X17 #110	FOR 220CHS-5000(FOR JE)			1

PRESSER MECHANISM COMPONENTS

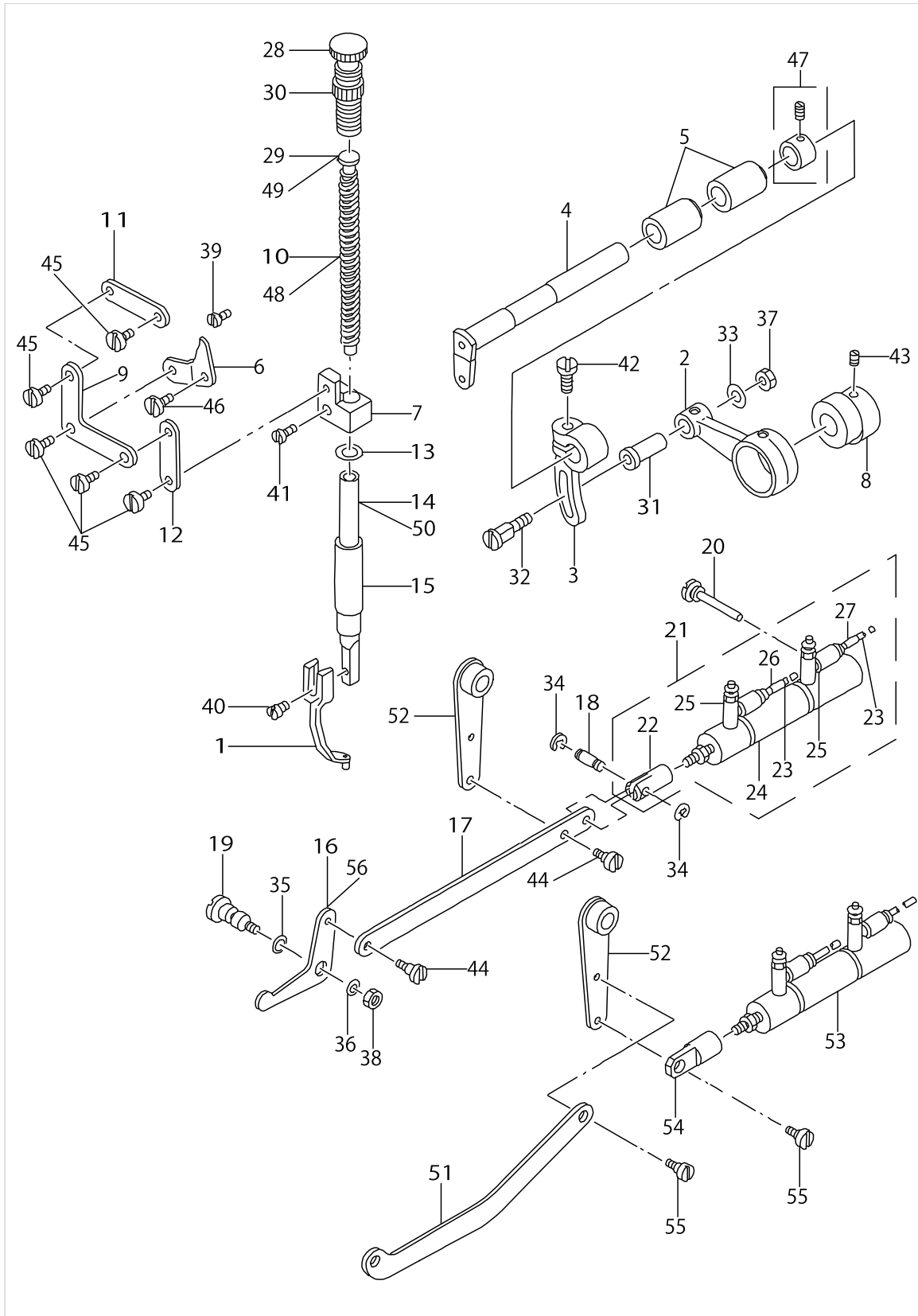

PRESSER MECHANISM COMPONENTS

No.	Parts No.	Parts name	Remarks	Level	Cons	Qty
1	B1601220000	INTERMEDIATE PRESSER A				1
2	B1602220000	INTERMEDIATE PRESSER ROD				1
3	B1603220000	INTERMEDIATE PRESSER ROD ARM				1
4	B1604220000	INTERMEDIATE PRESSER SHAFT				1
5	B1605220000	INTERMEDIATE PRESSER BUSHING				2
6	B1606220000	POSITIONING LINK				1
7	B1608220000	GUIDE BRACKET				1
8	B1609220000	CAM				1
9	B1610220000	L-SHAPED LINK				1
10	B1611220000	SPRING	FOR 220CSS-5000			1
11	B1612220000	SUSPENSION LINK A				1
12	B1613220000	SUSPENSION LINK B				1
13	B1614220000	SPACER				1
14	B1615220000	PRESSER BAR	FOR 220CSS-5000			1
15	B1616220000	PRESSER BAR BUSHING, LOWER				1
16	B1620220000	LIFTING LINK				1
17	B1621220000	CONNECTING LINK	FOR 220CSS-5000			1
18	B1626220000	CYLINDER PIN	FOR 220CSS-5000			1
19	B1627220000	LINK PIVOT PIN				1
20	B1628220000	CYLINDER SUPPORT SCREW				1
21	B16242200A0	CYLINDER ASM.	FOR 220CSS-5000			1
22	B1625220000	CYLINDER KNUCKLE		*		1
23	B471022000D	AIR TUBE D D=4		*		2
24	PA1601506A0	AIR CYLINDER		*		1
25	PC010508000	SPEED CONTROLLER		*		2
26	B471122000A	AIR TUBE LABEL J01		*		1
27	B471122000B	AIR TUBE LABEL J02		*		1
28	B1509227000	PRESSER SPRING REGULATOR				1
29	B1510227000	PRESSER GUIDE BAR	FOR 220CSS-5000			1
30	11071701	NUT				1
31	D1455055B00	CONNECTING STUD				1
32	D1456055B00	HINGE SCREW				1
33	D1457055B00	WASHER				1
34	RE0300000K0	E-SHAPED SNAP RING (3MM)	FOR 220CSS-5000			2
35	RO048190100	RUBBER RING				1
36	WP0612066SP	WASHER 6.1X11X2				1
37	NS6110530SP	NUT 11/64-40				1
38	NS6150430SP	NUT 15/64-28				1
39	SS6150710SP	SCREW				1
40	SS7091110SP	SCREW 9/64-40 L=10.5				1
41	SS7111410TP	SCREW 11/64-40 L=14				1
42	SS7661540SP	SCREW 1/4-40 L=15.0				1
43	SS8660610TP	SCREW 1/4-40 L=6				2
44	SD0640321SP	HINGE SCREW D= 6.35 H= 3.2	FOR 220CSS-5000			2
45	SD0640321TP	HINGE SCREW				5
46	SD0720321TP	HINGE SCREW				1
47	CS111101CSH	THRUST COLLAR ASM.D=11.11 W=10				1

PRESSER MECHANISM COMPONENTS

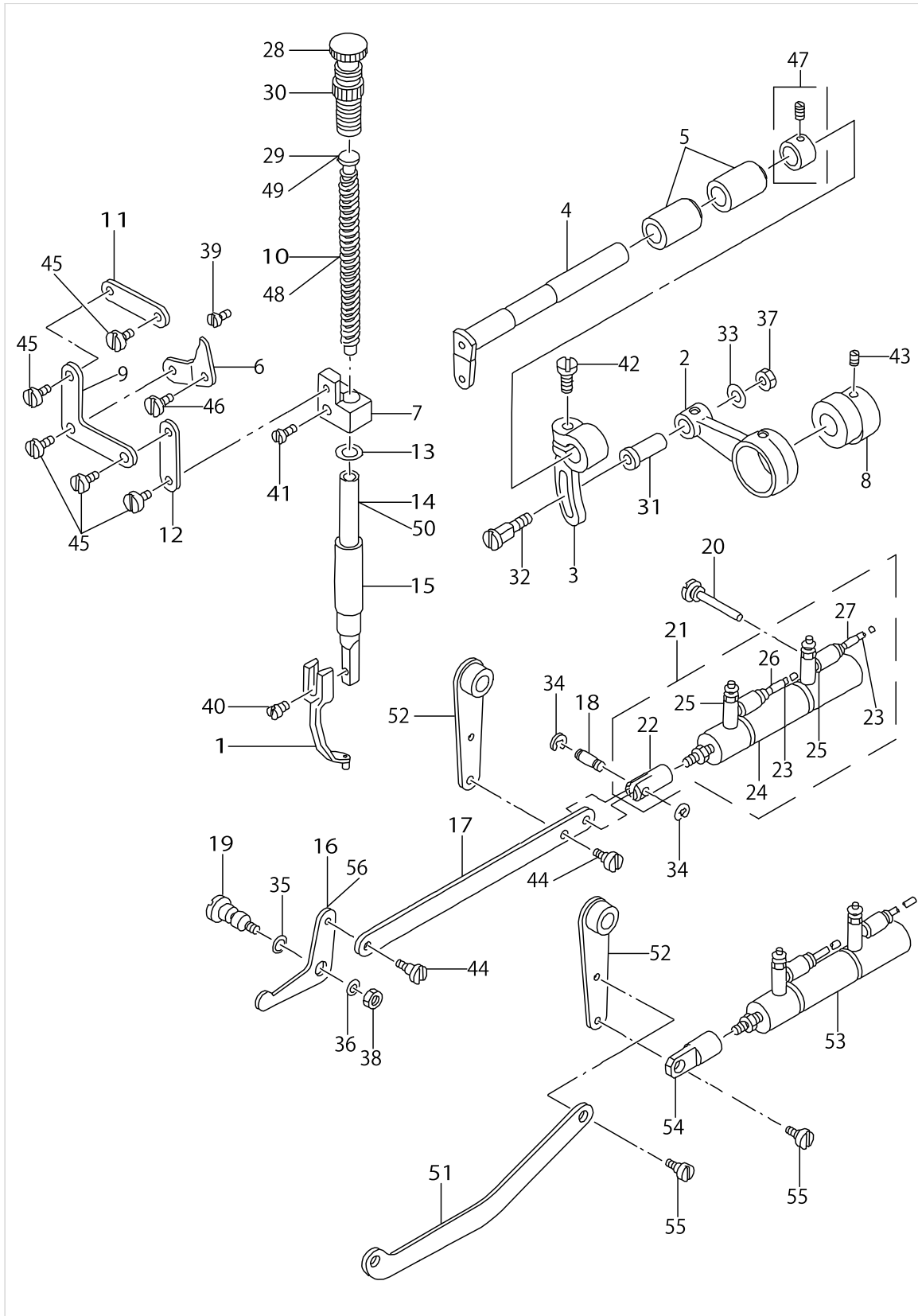

PRESSER MECHANISM COMPONENTS

No.	Parts No.	Parts name	Remarks	Level	Cons	Qty
48	B1611224000	SPRING	FOR 220CHS-5000			1
49	B1629224000	PRESSER GUIDE BAR	FOR 220CHS-5000			1
50	B1615224000	PRESSER BAR	FOR 220CHS-5000			1
51	B1621224000	CONNECTING LINK	FOR 220CHS-5000			1
52	B1622224000	CONNECTING LINK ARM				1
53	PA1603003A0	INTERMEDIATE PRESSER CYLINDER	FOR 220CHS-5000			1
54	B1625224000	CYLINDER KNUCKLE	FOR 220CHS-5000			1
55	SD0640321SP	HINGE SCREW D= 6.35 H= 3.2	FOR 220CHS-5000			2
56	B1620224000	LIFTING LINK	FOR 220CHS-5000			1

SHUTTLE DRIVER SHAFT COMPONENTS

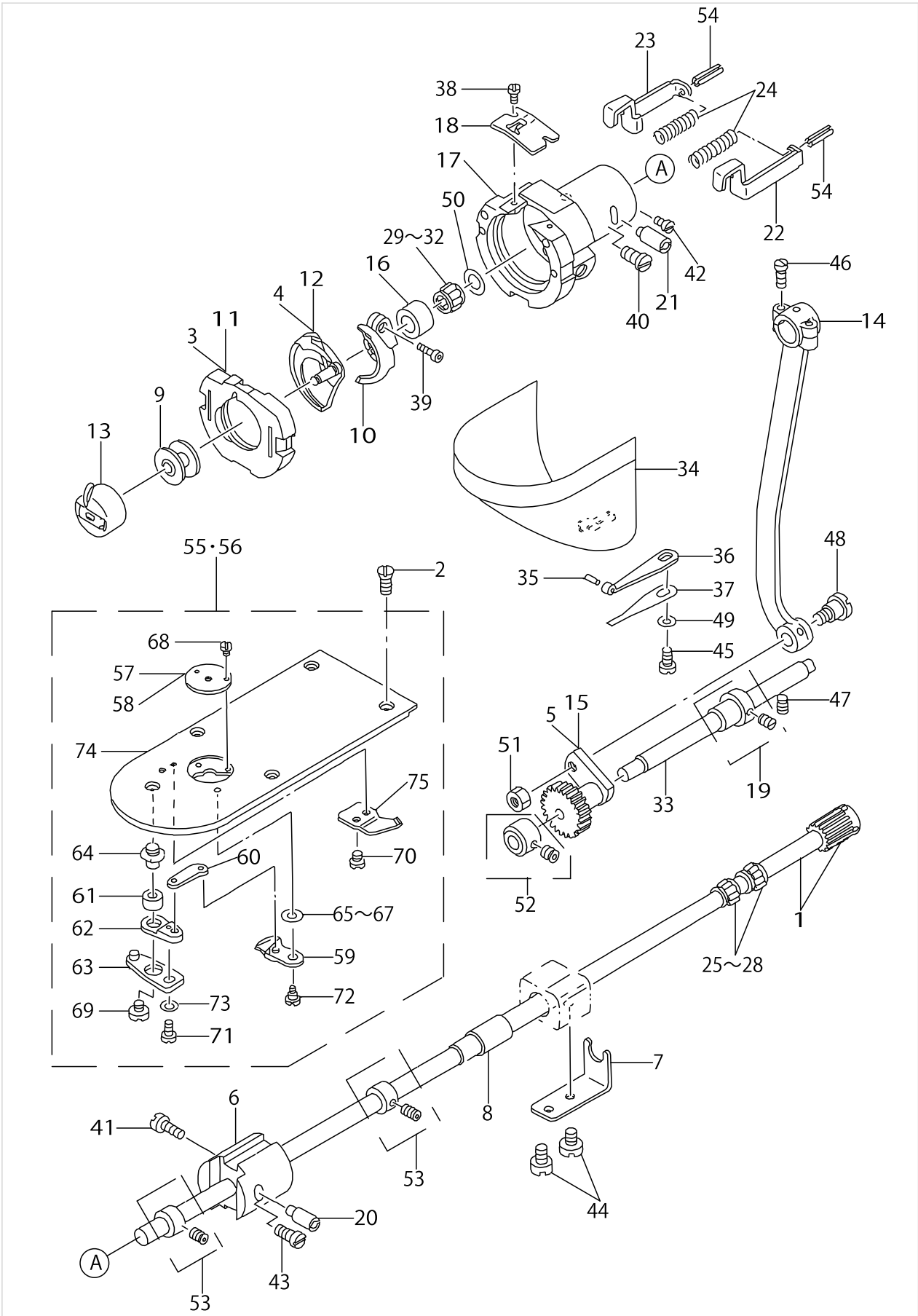

SHUTTLE DRIVER SHAFT COMPONENTS

No.	Parts No.	Parts name	Remarks	Level	Cons	Qty
1	B18112200AA	SHUTTLE DRIVER SHAFT ASM. A				1
2	SS1110640TP	SCREW 11/64-40 L= 5.5				4
3	B18172050AB	SHUTTLE RACE RING ASM.	FOR 220CHS-5000			1
4	B181820500B	SHUTTLE	FOR 220CHS-5000			1
5	D1805MLBH00	OSCILLATING ROCK SHAFT	FOR 220CHS-5000			1
6	B1831220000	BUSHING, FRONT				1
7	B1832220000	NEEDLE STOPPER				1
8	13508403	LOWER SHAFT REAR METAL				1
9	B1805205000	BOBBIN				1
10	B1812205000	SHUTTLE DRIVER				1
11	B18172050A0	SHUTTLE RACE RING ASM.	FOR 220CSS-5000			1
12	B1818205000	SHUTTLE	FOR 220CSS-5000			1
13	B18282050A0	BOBBIN CASE ASM.				1
14	B1802210000	CRANK ROD				1
15	B1805980000	OSCILLATOR	FOR 220CSS-5000			1
16	B1813980000	SHUTTLE NEEDLE OUTER RING				1
17	B1814980000	SHUTTLE				1
18	B1815980000	SHUTTLE UPPER SPRING				1
19	B18042800A0	THRUST COLLAR ASM.				1
20	B1819280000	SHUTTLE RACE ADJUSTING SHAFT				1
21	B1819280000	SHUTTLE RACE ADJUSTING SHAFT				1
22	B1820280000	INNER HOOK PRESSER, RIGHT				1
23	B1821280000	INNER HOOK PRESSER, LEFT				1
24	B1823280000	INNER HOOK PRESSER SPRING				2
25	B1411804A00	BEARING (A)				2
26	B1411804B00	NEEDLE DRIVING LEVER BEARING B	SELECTIVE PART			2
27	B1411804C00	NEEDLE DRIVING LEVER BEARING C	SELECTIVE PART			2
28	B1411804D00	BEARING (D)	SELECTIVE PART			2
29	B1411804A00	BEARING (A)				1
30	B1411804B00	NEEDLE DRIVING LEVER BEARING B	SELECTIVE PART			1
31	B1411804C00	NEEDLE DRIVING LEVER BEARING C	SELECTIVE PART			1
32	B1411804D00	BEARING (D)	SELECTIVE PART			1
33	13508205	OSCILLATING SHAFT				1
34	13816855	CYLINDER ARM CAP				1
35	13508700	HOOK COVER PRESSER SPRING PIN				1
36	13508809	HOOK COVER PRESSER SPRING A				1
37	13508908	HOOK COVER PRESSER SPRING B				1
38	SS6060410TP	SCREW 3/32-56 L= 3.5				2
39	SS6121212TP	SCREW 3/16-28 L=12.0				1
40	SS6151220SP	SCREW 15/64-28 L=11.5				1
41	SS6151220SP	SCREW 15/64-28 L=11.5				1
42	SS7110510SP	SCREW 11/64-40 L=5				1
43	SS7110510SP	SCREW 11/64-40 L=5				1
44	SS7110710SP	SCREW 11/64-40 L=7				2
45	SS7110840SP	SCREW 11/64-40 L=7.8				1
46	SS7111110TP	SCREW 11/64-40 L=10.5				2
47	SS8150822TP	SCREW 15/64-28 L=8				1

SHUTTLE DRIVER SHAFT COMPONENTS

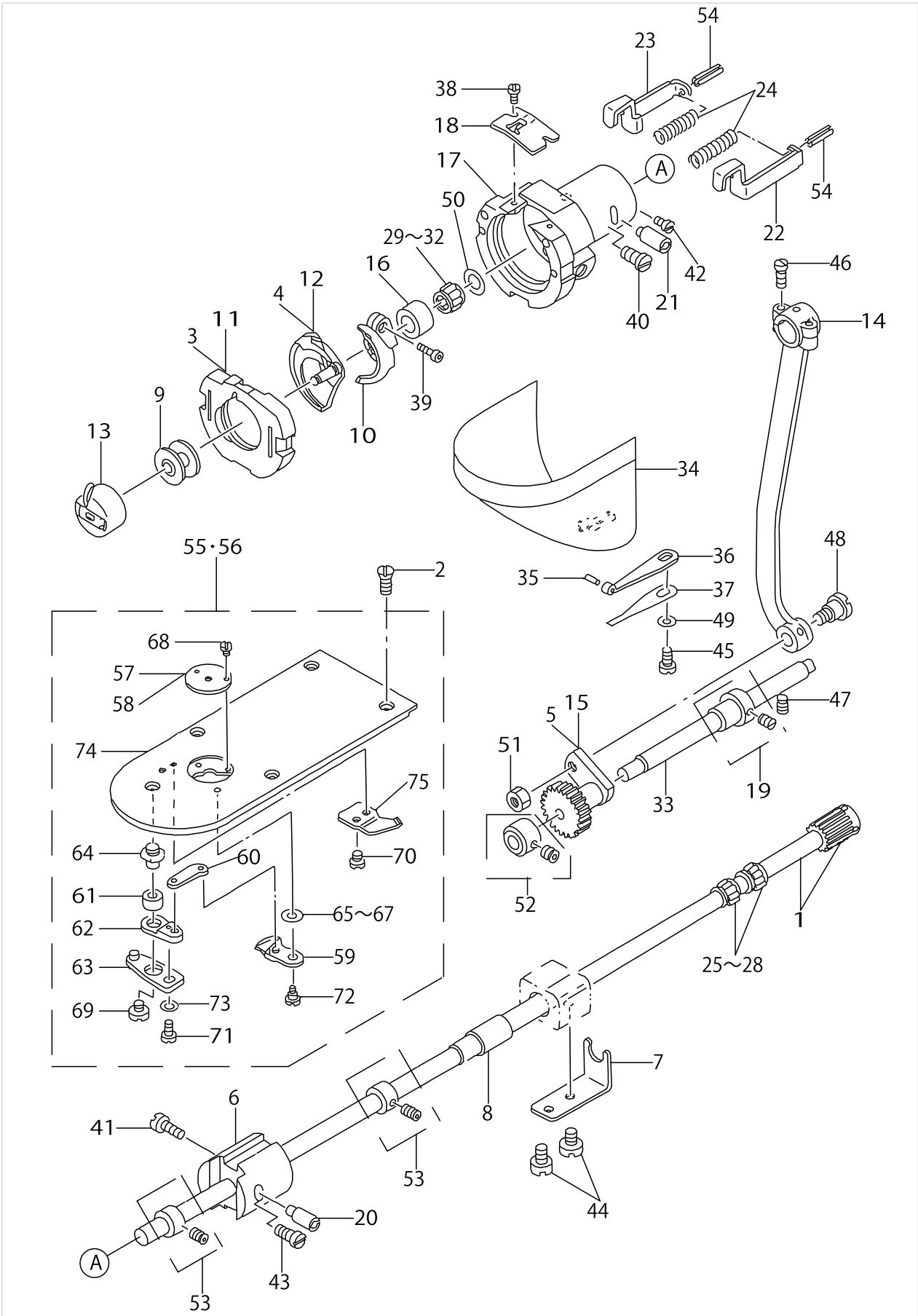

SHUTTLE DRIVER SHAFT COMPONENTS

No.	Parts No.	Parts name	Remarks	Level	Cons	Qty
48	SD0801021TP	HINGE SCREW D= 8 H=10.2				1
49	WP0531000SD	WASHER M5				1
50	WP0952616SD	WASHER 9.5X14.8X2.6				1
51	NS6660430SP	NUT 1/4-40				1
52	CS079101FSH	THRUST COLLAR ASM.				1
53	CS080081FSH	THRUST COLLAR ASM.				2
54	PS0250162KH	SPRING PIN 2.5X16				2
55	B24252240A0	NEEDLE PLATE ASM.	FOR 220CSS-5000			1
56	B24252200AB	NEEDLE PLATE ASM. (H)	FOR 220CHS-5000			1
57	B242621000A	NEEDLE HOLE GUIDE D=1.6	FOR 220CSS-5000	*		1
58	B242621000B	NEEDLE HOLE GUIDE D=2.0	FOR 220CHS-5000	*		1
59	B24212050A0	MOVING KNIFE ASM.		*		1
60	B2418280000	MOVING KNIFE LINK		*		1
61	B2416280000	THREAD CUTTING LEVER RING		*		1
62	B24152800A0	THREAD CUTTER LEVER ASM., SMAL		*		1
63	B24142800A0	THREAD CUTTER LEVER ASM., LARG		*		1
64	B2417280000	THREAD CUTTER LEVER SHAFT		*		1
65	B242328000A	MOVING KNIFE WASHER A		*		1
66	B242328000B	MOVING KNIFE WASHER B	SELECTIVE PART	*		1
67	B242328000C	MOVING KNIFE WASHER C	SELECTIVE PART	*		1
68	SS1060210TP	SCREW 3/32-56 L=2.2		*		2
69	SS6110430TP	SCREW 11/64-40 L= 4.0		*		1
70	SS7090410SP	SCREW 9/64-40 L= 3.5		*		2
71	SS7110740TP	SCREW 11/64-40 L=7		*		1
72	SD0600101TP	HINGE SCREW		*		1
73	WP0450846SP	WASHER		*		1
74	B2425224000	NEEDLE PLATE		*		1
75	B2424210000	COUNTER KNIFE		*		1

WIPER MECHANISM COMPONENTS

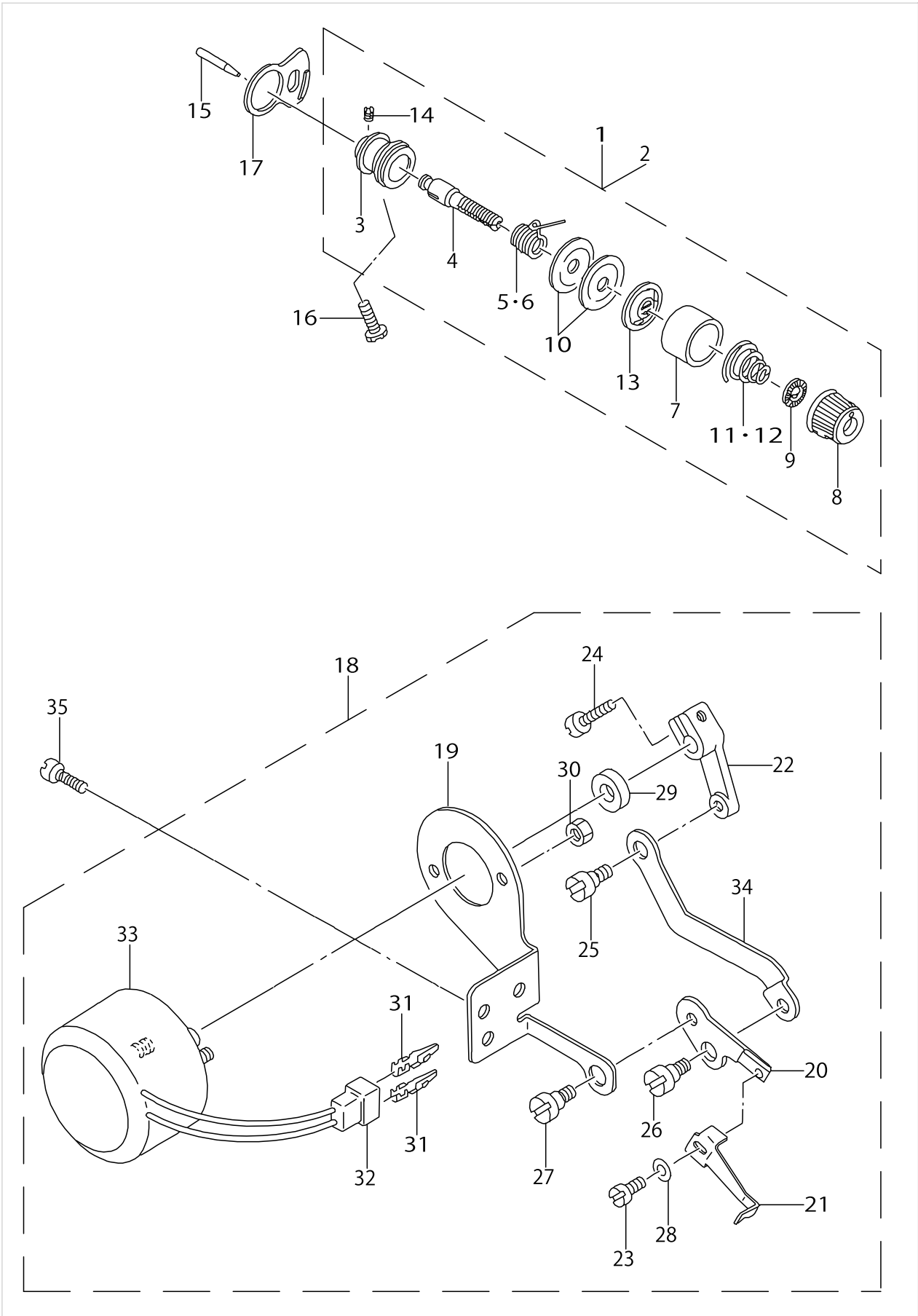

WIPER MECHANISM COMPONENTS

No.	Parts No.	Parts name	Remarks	Level	Cons	Qty
1	13817457	THREAD TENSION NO.2 CONNEC.	FOR 220CSS-5000			1
2	B23022050A0	TENSION CONTROLLER NO.2 ASM.	FOR 220CHS-5000			1
3	B2313280000	THREAD TENSION ROD, LARGE		*		1
4	B2302280000	SECOND THREAD TENSION ROD		*		1
5	B3112761000	THREAD TAKE-UP SPRING	FOR 220CSS-5000	*		1
6	D3112L4BB00	TAKE-UP SPRING (HEAVY)	FOR 220CHS-5000	*		1
7	B3107804000	THREAD TENSION DISK PRESSER		*		1
8	13817408	THREAD TENSION NUT		*		1
9	B3120125000	ROTATING STOPPER		*		1
10	B3126012000	THREAD TENSION DISK		*		2
11	B3114232000	THREAD TENSION SPRING	FOR 220CSS-5000	*		1
12	B3129053000	TENSION SPRING	FOR 220CHS-5000	*		1
13	B3132552000	THREAD TENSION DISK PRESSER		*		1
14	SS8090610SP	SCREW 9/64-40 L=5.9		*		1
15	B2303280000	TENSION RELEASE PIN				1
16	SS6151812TP	SCREW 15/64-28 L=18				1
17	B2702210000	GUIDE PLATE				1
18	B21012200A0	WIPER ASM.				1
19	B2104220000	SOLENOID INSTALLING PLATE		*		1
20	B2106220000	WIPER INSTALLING PLATE		*		1
21	B2107210000	WIPER		*		1
22	B2102205000	WIPER ARM.		*		1
23	SS6090630TP	SCREW 9/64-40 L=6		*		1
24	SS6621220SP	SCREW 3/16-32 L=12		*		1
25	SD0600352SP	HINGE SCREW		*		1
26	SD0640321SP	HINGE SCREW D= 6.35 H= 3.2		*		1
27	SD0640321SP	HINGE SCREW D= 6.35 H= 3.2		*		1
28	WP0371016SD	WASHER 3.7X8X1		*		1
29	WP0561616SC	WASHER 5.6X16X1.6		*		1
30	NM6040003SC	NUT M4		*		2
31	HP000200200	PIN-SHAPE TERMINAL, MALE		*		2
32	HK018800020	2-POLE PLUG		*		1
33	B2101220000	WIPER SOLENOID		*		1
34	B2103220000	WIPER CONNECTING PLATE		*		1
35	SS7110840SP	SCREW 11/64-40 L=7.8				2

TENSION RELEASE & THREAD TRIMMER MECHANISM COMPONENTS

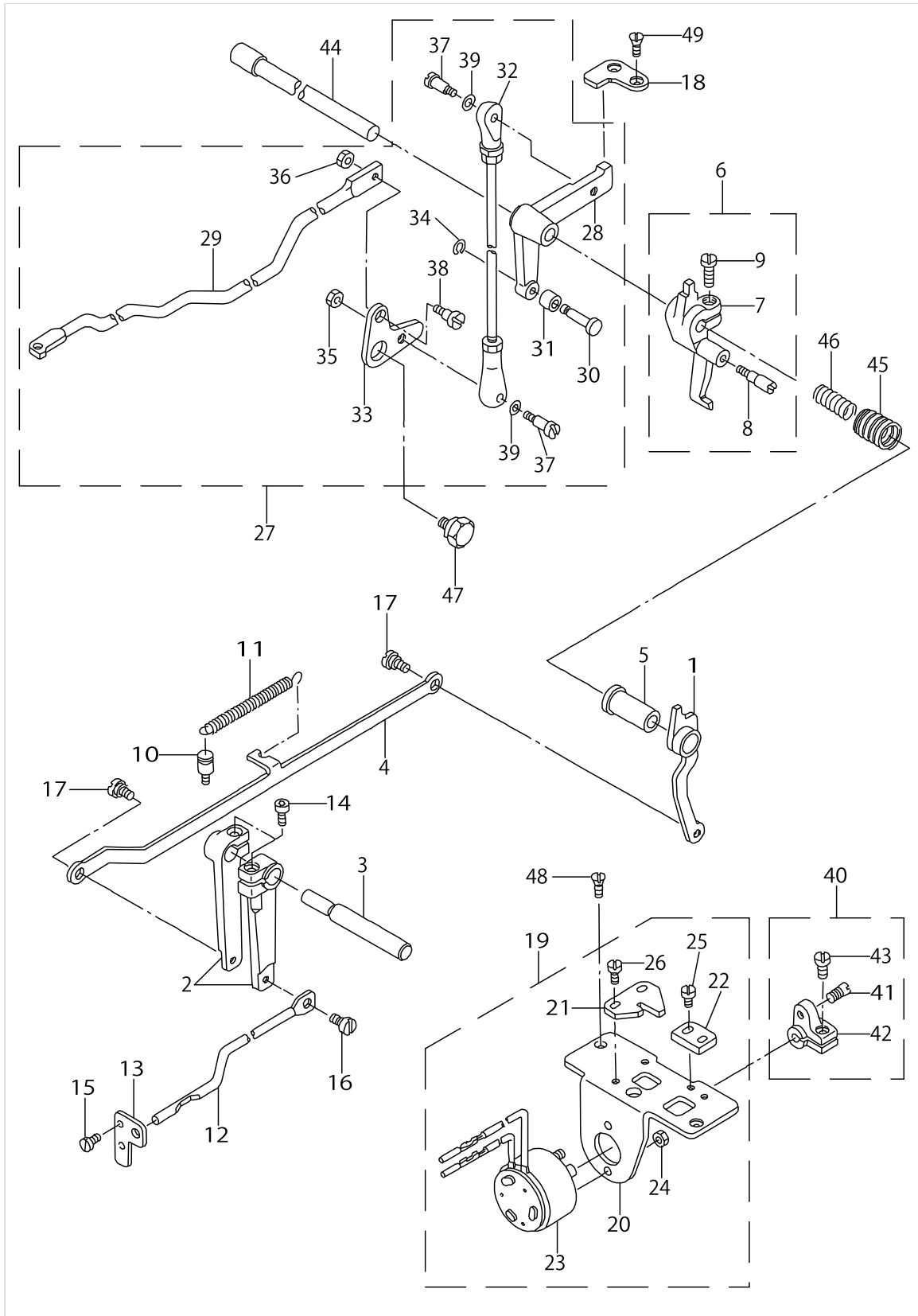

TENSION RELEASE & THREAD TRIMMER MECHANISM COMPONENTS

No.	Parts No.	Parts name	Remarks	Level	Cons	Qty
1	B23042200A0	TENSION RELEASE ARM ASM.				1
2	B2306220000	TENSION ARM				2
3	B2307220000	TENSION ARM SHAFT				1
4	B2308220000	CONNECTING PLATE				1
5	B2305210000	BUSHING				1
6	B23012100A0	TENSION RELEASE ARM ASM.				1
7	B2301210000	TENSION RELEASE ARM		*		1
8	B2302210000	TENSION RELEASE SHAFT		*		1
9	SS6121220TP	SCREW 3/16-28 L=11.5		*		1
10	B2714761000	SPRING RACK				1
11	B2727761000	TENSION SPRING				1
12	13513205	TENSION RELEASE BAR				1
13	13513304	THREAD TENSION ARM				1
14	SS6151712TP	SCREW 15/64-28 L=16.5				2
15	SS7090620TP	SCREW 9/64-40 L=6.1				2
16	SD0530221SP	HINGE SCREW D= 5.3 H= 2.2				1
17	SD0640321SP	HINGE SCREW D= 6.35 H= 3.2				2
18	B2412220000	STOPPER				1
19	B24022200A0	SOLENOID INSTALLING BASE ASM.				1
20	B2402220000	SOLENOID INSTALLING BASE		*		1
21	B2310220000	TENSION RELEASE ARM PLATE		*		1
22	B2311220000	Y MOTOR BASE STOPPER		*		1
23	B2403210000	SOLENOID		*		1
24	NM6040003SC	NUT M4		*		2
25	SS7110840SP	SCREW 11/64-40 L=7.8		*		2
26	SS7110840SP	SCREW 11/64-40 L=7.8		*		2
27	B24042200A0	CAM INSTALLING LINK ASM.				1
28	B2404220000	CAM INSTALLING LINK		*		1
29	B2413220000	KNIFE DRIVING BAR		*		1
30	B2405210000	SHAFT		*		1
31	B2406210000	CAM ROLLER		*		1
32	B2407210000	CONNECTING ROD		*		1
33	B2411210000	THREAD TRIMMER LINK		*		1
34	D2430555B00	SNAP RING		*		1
35	NS6110420SP	NUT 11/64-40		*		1
36	NS6120310SP	NUT 3/16-28		*		1
37	SD0500803TP	HINGE SCREW D=5 H=8		*		2
38	SD0650305TP	HINGE SCREW D= 6.5 H= 3		*		1
39	WP0501016SD	WASHER 5X10.5X1		*		2
40	B24102200A0	SOLENOID ARM ASM.				1
41	B2410220000	PIN		*		1
42	B2409210000	SOLENOID ARM		*		1
43	SS6121210SP	SCREW 3/16-28 L=12		*		1
44	B2408210000	CAM SHAFT				1
45	B2414210000	SPRING, LARGE				1
46	B2415210000	SPRING, SMALL				1
47	SD1100301TP	HINGE SCREW H=11 W=3				1

TENSION RELEASE & THREAD TRIMMER MECHANISM COMPONENTS

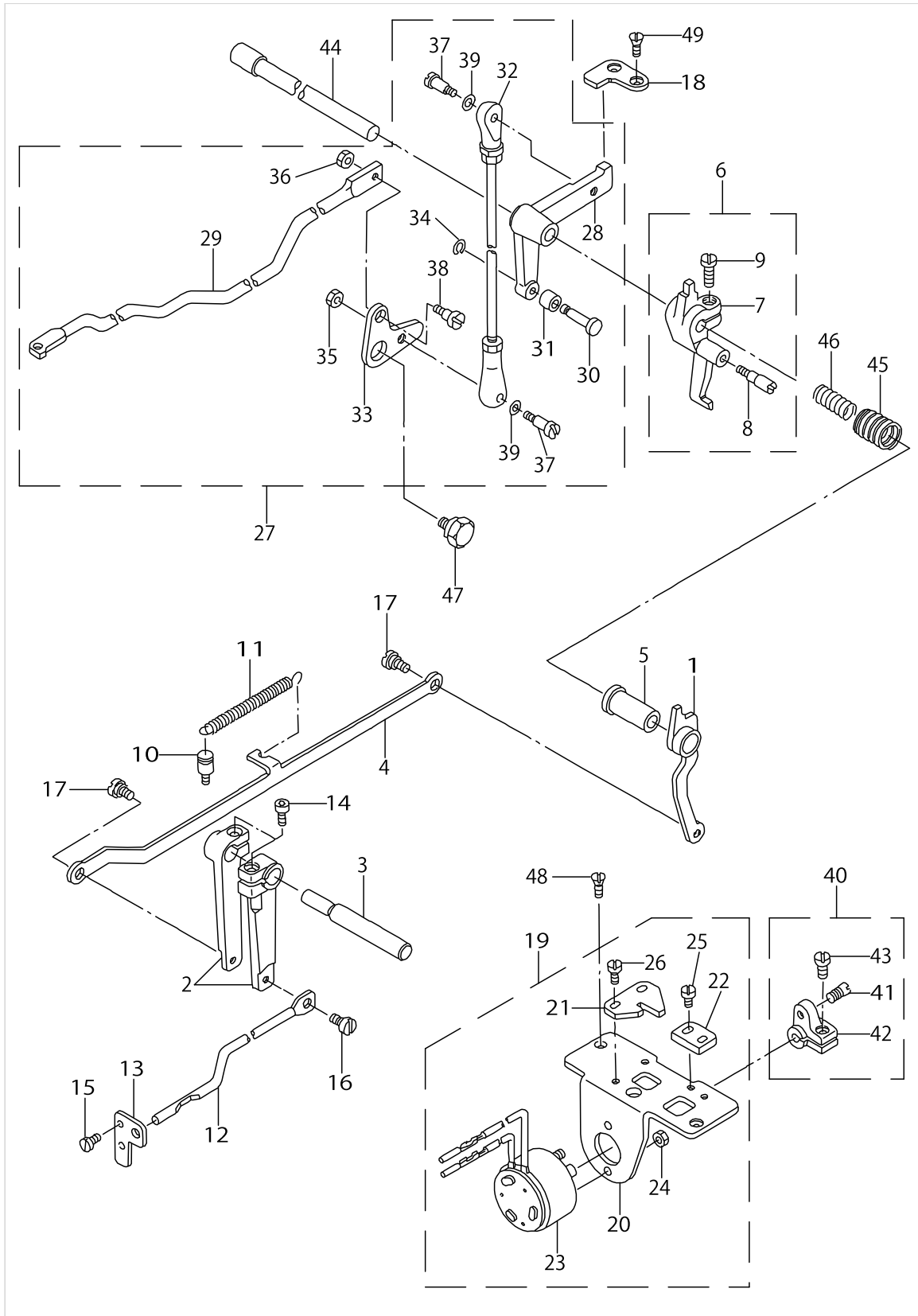

TENSION RELEASE & THREAD TRIMMER MECHANISM COMPONENTS

No.	Parts No.	Parts name	Remarks	Level	Cons	Qty
48	SS2110920TP	SCREW 11/64-40 L=8.5				2
49	SS2110920TP	SCREW 11/64-40 L=8.5				2

X-Y COMPONENTS (1)

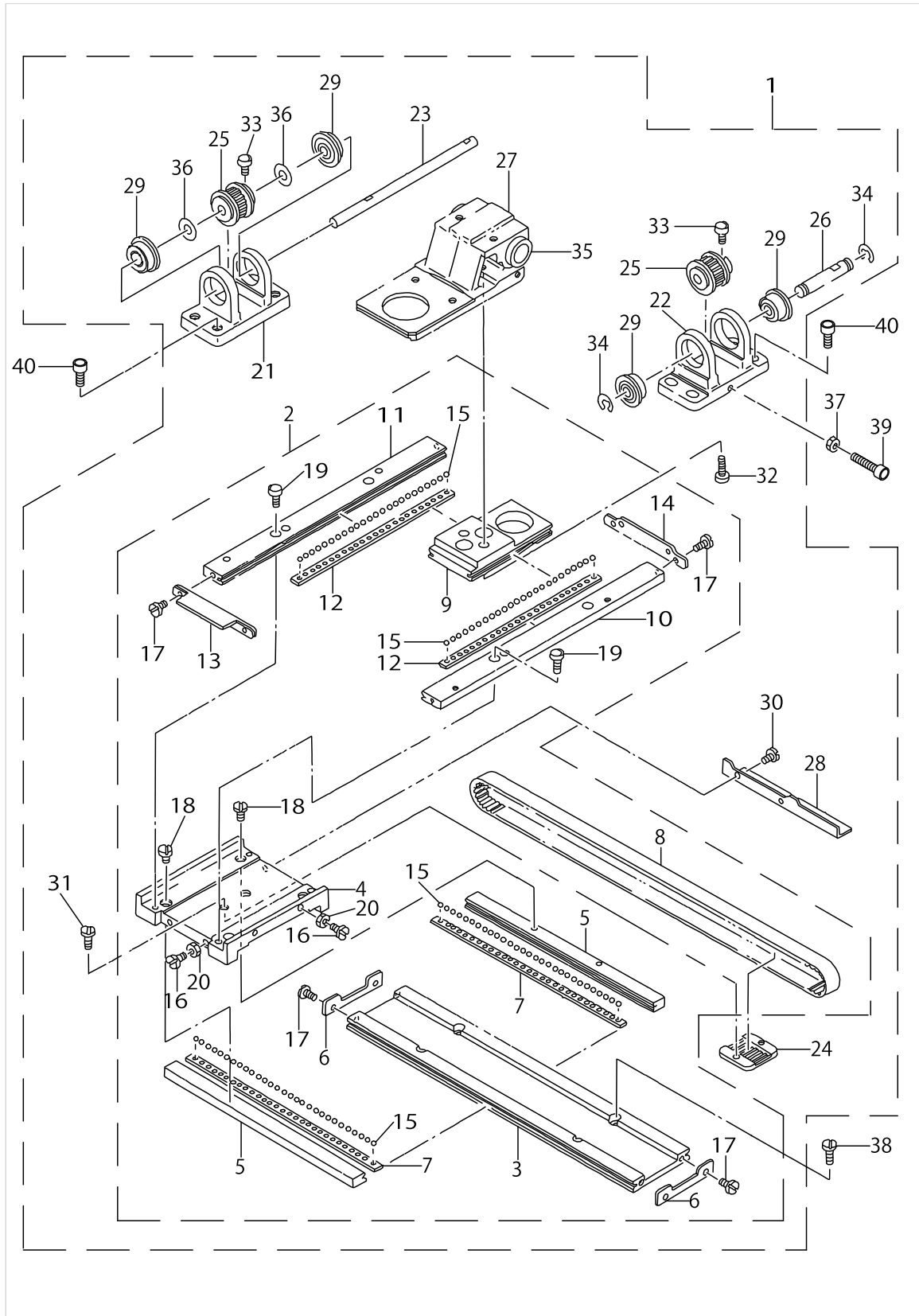

X-Y COMPONENTS (1)

No.	Parts No.	Parts name	Remarks	Level	Cons	Qty
1	B2501220AB0	X-Y TABLE COMPL., A				1
2	B2501220AA0	X-Y TABLE ASM., A		*		1
3	B2501220000	X FIXED LACE		*		1
4	B2502220000	RACE TABLE		*		1
5	B2503220000	X REMOVAL LACE		*		2
6	B2507220000	X STOPPER		*		2
7	B2508220000	X RETAINER		*		2
8	B2512220A00	X TIMING BELT A		*		1
9	B2519220000	Y REMOVAL LACE		*		1
10	B252022000A	Y FIXED LACE, RIGHT		*		1
11	B252022000B	Y FIXED LACE, LEFT		*		1
12	B2521220000	Y RETAINER		*		2
13	B25222200AA	Y STOPPER ASM. A		*		1
14	B252222000C	Y STOPPER C		*		1
15	B2527210000	BALL		*		106
16	SS7111110TP	SCREW 11/64-40 L=10.5		*		4
17	SS9111010SP	SCREW 11/64-40 L=9.5		*		8
18	SS7110910TP	SCREW 11/64-40 L= 8.5		*		4
19	SM6041402TP	SCREW M4 L=14		*		4
20	NS6110310SP	NUT 11/64-40		*		4
21	B2504220000A	X SHAFT BRACKET		*		1
22	B2505220000A	X DRIVING SHAFT BRACKET		*		1
23	B2506220000B	X DRIVE SHAFT		*		1
24	B2509229000	BELT RECEIVER		*		1
25	B2513220A00	SPROCKET WHEEL A		*		2
26	B2515220000	X BRACKET SHAFT		*		1
27	B2535220000	X GUIDE BASE		*		1
28	B4007220000	X SLIT PLATE		*		1
29	SB108000500	RADIAL BEARING		*		4
30	SM6040552TP	SCREW M4 L=4.5		*		2
31	SS6110610TP	SCREW 11/64-40 L=6		*		2
32	SS6151812TP	SCREW 15/64-28 L=18		*		2
33	B2540205B00	SCREW		*		4
34	RE0600000K0	E-SHAPED SNAP RING (6MM)		*		2
35	SB712000100	SLIDE BEARING		*		2
36	B255728000E	WASHER		*		2
37	NM6050001SE	NUT M5X0.8				1
38	SS6121210SP	SCREW 3/16-28 L=12				4
39	SM6053002UZ	HEXAGON SCREW				1
40	SM6051602TP	SCREW M5X0.8 L=16				8

X-Y COMPONENTS (2)

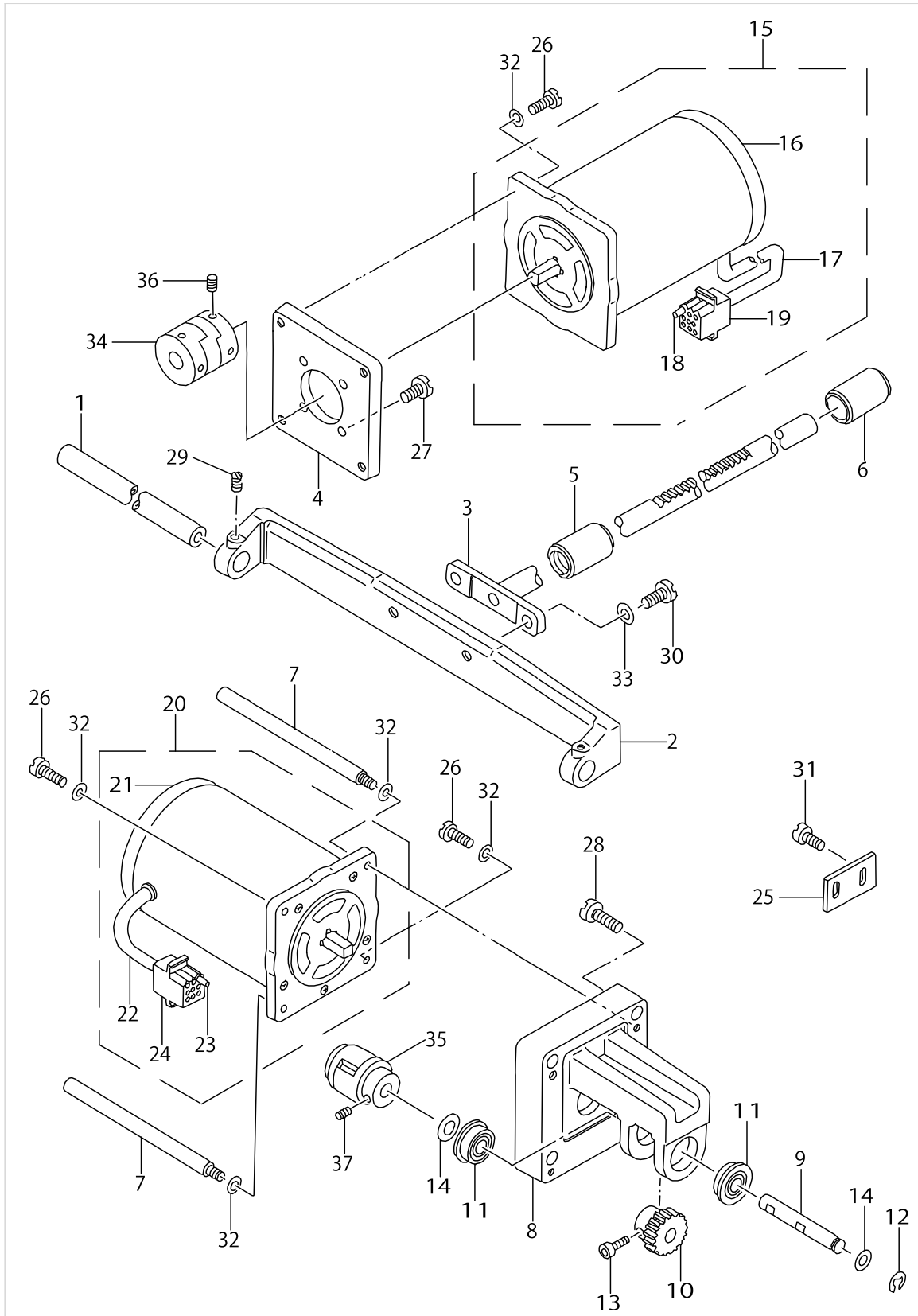

X-Y COMPONENTS (2)

No.	Parts No.	Parts name	Remarks	Level	Cons	Qty
1	B2510220000	X GUIDE SHAFT				1
2	B2511220000	X GUIDE SHAFT BRACKET				1
3	B25242200A0	Y REMOVAL SHAFT ASM.				1
4	B2531220000	MOTOR BASE				1
5	B2532220000	BUSHING, FRONT				1
6	B2533220000	BUSHING, REAR				1
7	B1161220B00	MOTOR STUD BOLT B				2
8	B2517220A00	Y MOTOR BASE A				1
9	B2523220000A	Y DRIVE SHAFT				1
10	B2526220000	Y DRIVE GEAR				1
11	SB108000500	RADIAL BEARING				2
12	RE0600000K0	E-SHAPED SNAP RING (6MM)				1
13	B2540205B00	SCREW				2
14	WP0820526SD	WASHER 8.2X14X0.5				2
15	B2529220ABA	X STEPPING MOTOR ASM., B				1
16	B2529220A00	STEPPING MOTOR		*		1
17	E8760452M00	TUBE		*		0.6
18	D6042555B00	PIN TERMINAL, FEMALE		*		5
19	D8604761C0B	9P RECEPTACLE (BLUE)		*		1
20	B2529220ABB	Y STEPPING MOTOR ASM., B				1
21	B2529220A00	STEPPING MOTOR		*		1
22	E8760452M00	TUBE		*		0.6
23	D6042555B00	PIN TERMINAL, FEMALE		*		5
24	D6028555B0B	9-POLE RECEPTACLE, WHITE		*		1
25	B2311220000	Y MOTOR BASE STOPPER				1
26	SS7121610SP	SCREW 3/16-28 L=15.5				6
27	SS7151210SP	SCREW 15/64-28 L=12				4
28	SS7152040SP	SCREW 15/64-28 L=20.0				4
29	SS8120740SP	SCREW 3/16-28 L=7				2
30	SS9151440CP	SCREW 15/64-28 L=14				2
31	SS7110840SP	SCREW 11/64-40 L=7.8				2
32	WP0501016SD	WASHER 5X10.5X1				8
33	WP0621016SD	WASHER 6.2X13X1				2
34	B25372200A0	X CUPLING				1
35	B2538220A00	Y COUPLING				1
36	SS8150822TP	SCREW 15/64-28 L=8				4
37	SM8061002TP	SCREW M6 L=10				4

CLOTH FEED MECHANISM COMPONENTS

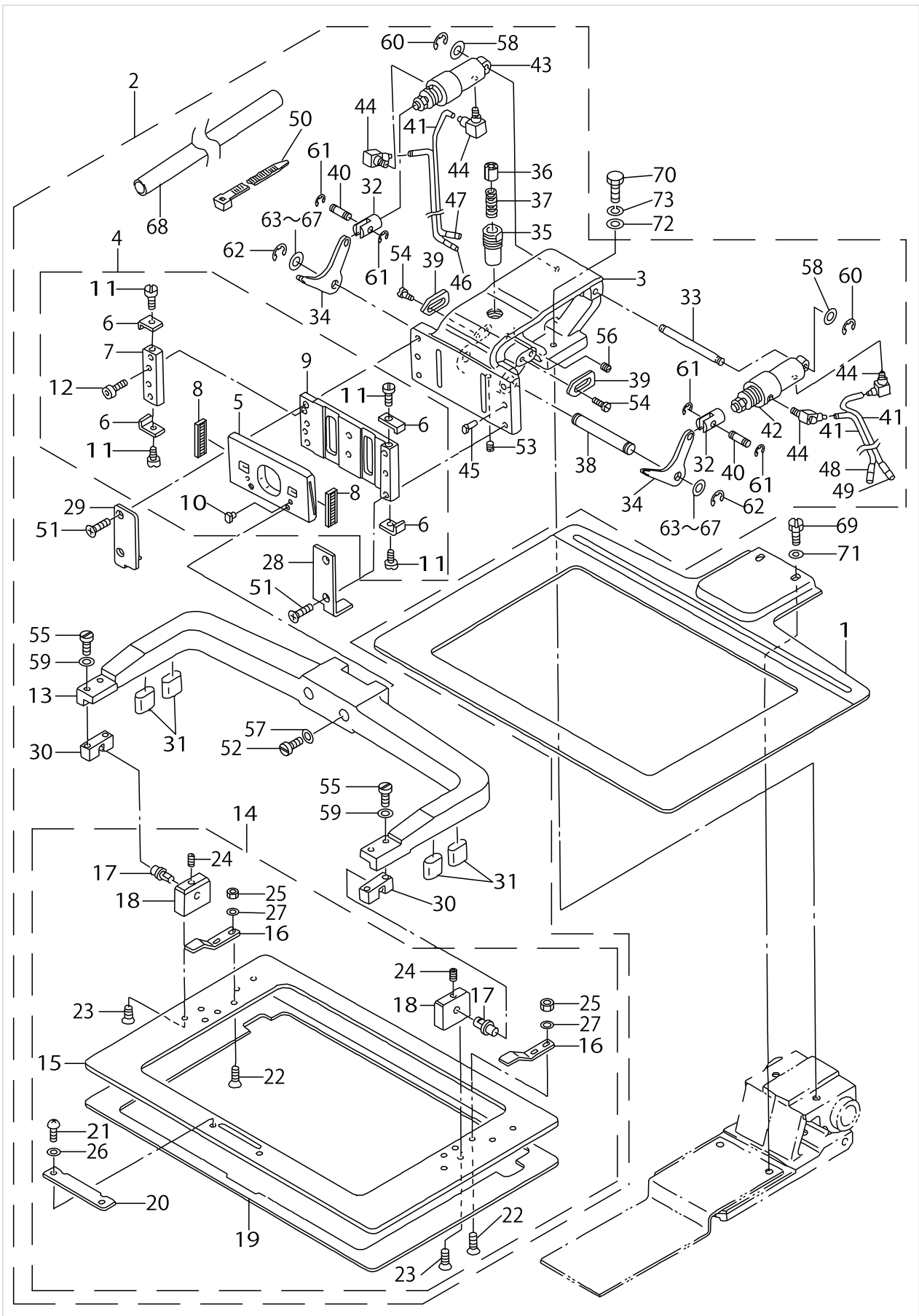

CLOTH FEED MECHANISM COMPONENTS

No.	Parts No.	Parts name	Remarks	Level	Cons	Qty
1	B2556220000	FEED PLATE				1
2	B25502200A0	CLOTH FEED BASE ASM.				1
3	B2550220000	FEED BRACKET		*		1
4	B25722200A0	WORK CLAMP FOOT PLATE ASM.		*		1
5	B2551220000	WORK CLAMP FOOT SLIDE PLATE		*		1
6	B2565220000	STOPPER		*		4
7	B2567220000	WORK CLAMP FOOT LACE		*		1
8	B2569220000	BEARING		*		2
9	B2572220000	WORK CLAMP FOOT PLATE		*		1
10	B1816280000	GUIDE PIN		*		2
11	SS7090530SP	SCREW 9/64-40 L= 4.5		*		4
12	SM6040602TP	SCREW M4 L=6		*		2
13	B2552220000	FEEDING FRAME ARM		*		1
14	B25532200A0	FEEDING FRAME ASM.		*		1
15	B2553220000	FEEDING FRAME		*		1
16	B2558220000	PLASTIC BLANK PLATE		*		2
17	B2560220000	SUPPORT PIN		*		2
18	B2561220000	BEARING BLOCK		*		2
19	B2564220000	SPONGE		*		1
20	B2592220000	PLASTIC BLANK STOPPER		*		1
21	SS4110515SP	SCREW 11/64-40 L=5		*		2
22	SS1110840SP	SCREW 11/64-40 L=8		*		4
23	SS1110840SP	SCREW 11/64-40 L=8		*		4
24	SS8110422TP	SCREW 11/64-40 L=4		*		2
25	NS6110360SP	NUT		*		4
26	WP0501016SD	WASHER 5X10.5X1		*		2
27	WP0450000SD	WASHER 4.5X8X0.5		*		4
28	B2554220000	RECEIVER PLATE, RIGHT		*		1
29	B2555220000	RECEIVER PLATE, LEFT		*		1
30	B2562220000	BALL CATCH		*		2
31	B256322400B	FEEDING FRAME RUBBER CUSHION		*		4
32	B2566220000	CYLINDER KNUCKLE		*		2
33	B2568220000	CYLINDER SHAFT		*		1
34	B2570220000	LIFTING LEVER		*		2
35	B2573220000	SLIDER RECEIVER		*		1
36	B2574220000	SLIDER		*		1
37	B2576220000	SLIDER SPRING		*		1
38	B2578220000	LIFTING LEVER SHAFT		*		1
39	B2580220000	STOPPER		*		2
40	B1626220000	CYLINDER PIN		*		2
41	B471022000C	AIR TUBE C D=4		*		4
42	PA1602503A0	WORK CLAMP FOOT CYLINDER,RIGHT		*		1
43	PA1602504A0	WORK CLAMP FOOT CYLINDER, LEFT		*		1
44	PJ046052503	HOSE ELBOW		*		4
45	B1816280000	GUIDE PIN		*		2
46	B471122000C	AIR TUBE LABEL J03 LEFT		*		1
47	B471122000D	AIR TUBE LABEL J04 LEFT		*		1

CLOTH FEED MECHANISM COMPONENTS

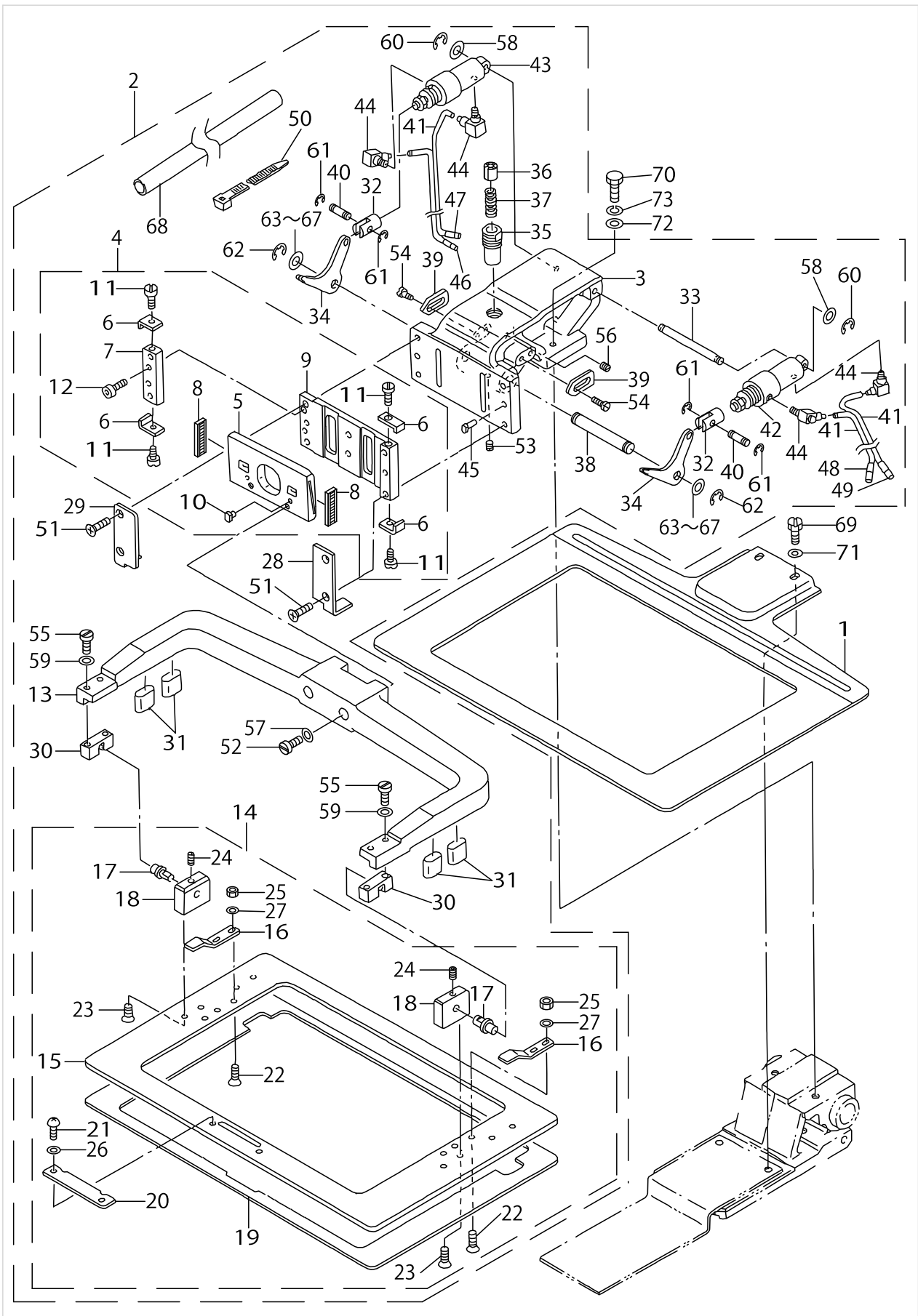

CLOTH FEED MECHANISM COMPONENTS

No.	Parts No.	Parts name	Remarks	Level	Cons	Qty
48	B471122000G	AIR TUBE LABEL J03 RIGHT		*		1
49	B471122000H	AIR TUBE LABEL J04 RIGHT		*		1
50	HX002330000	CLIP		*		3
51	SS2122410TP	SCREW		*		4
52	SS7151610SP	SCREW 15/64-28 L=16		*		2
53	SS8120740SP	SCREW 3/16-28 L=7		*		1
54	SS6120940SP	SCREW 3/16-28 L=9		*		4
55	SS6111610SP	SCREW 11/64-40 L=16		*		4
56	SS8120410SP	SCREW		*		1
57	WP0641600SC	WASHEW 6.4X12.5X1.6		*		2
58	WP0520656SA	WASHER 5.2X9.5X0.6		*		2
59	WP0450000SD	WASHER 4.5X8X0.5		*		4
60	RE0300000K0	E-SHAPED SNAP RING (3MM)		*		2
61	RE0300000K0	E-SHAPED SNAP RING (3MM)		*		4
62	RE0600000K0	E-SHAPED SNAP RING (6MM)		*		2
63	B255728000A	WASHER FOR DRIVING ARM		*		2
64	B255728000B	WASHER	SELECTIVE PART	*		2
65	B255728000C	WASHER	SELECTIVE PART	*		2
66	B255728000D	WASHER D	SELECTIVE PART	*		2
67	B255728000E	WASHER	SELECTIVE PART	*		2
68	HX003290000	CABLE BAND		*		0.2
69	SS9150710TP	BOLT 15/64-28 L=6.5				2
70	SS9152130CP	SCREW 15/64-28 L=20.5				2
71	WP0621016SD	WASHER 6.2X13X1				2
72	WP0641600SC	WASHEW 6.4X12.5X1.6				2
73	WS0631510KP	SPRING WASHER				2

LUBRICATION COMPONENTS

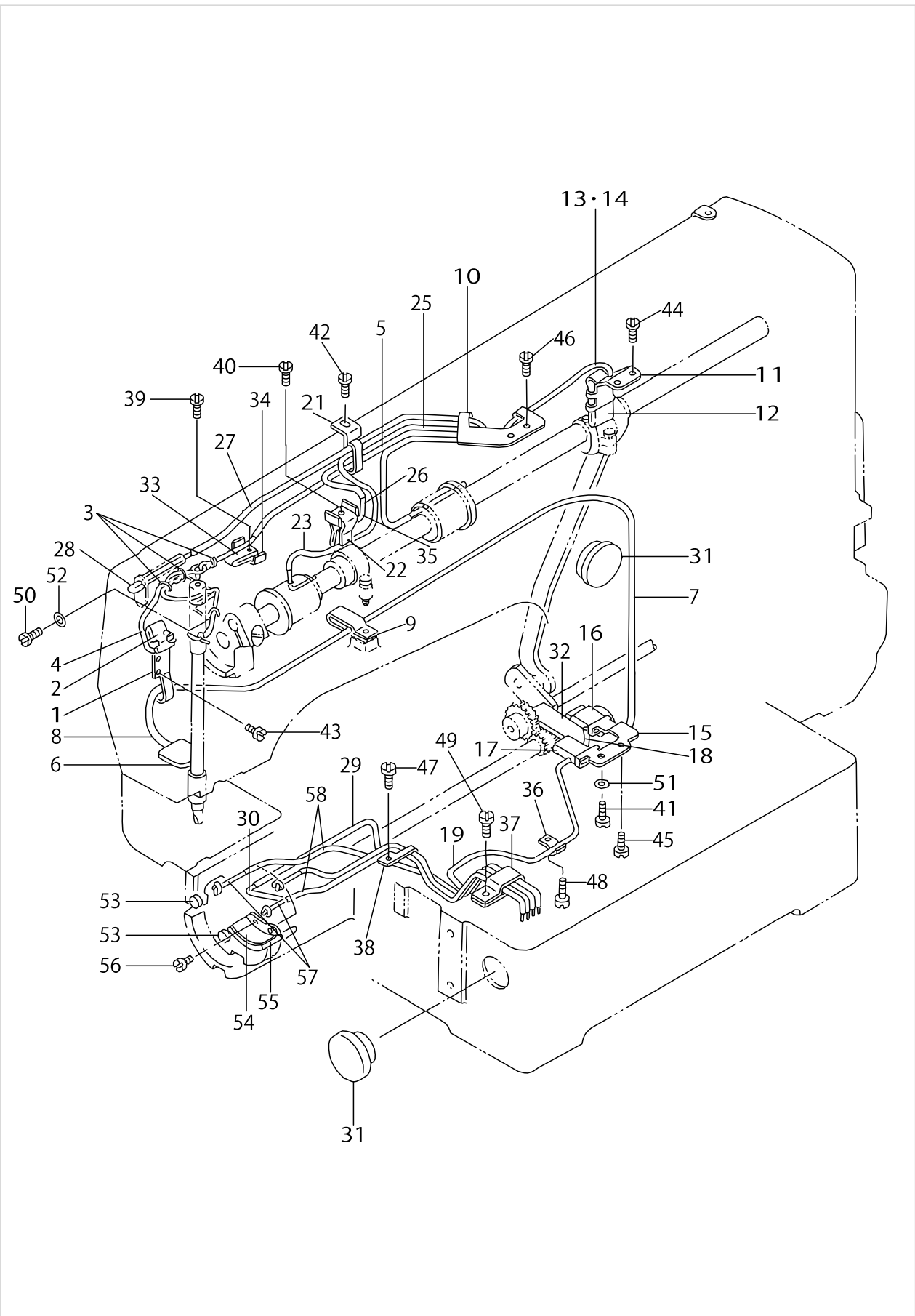

LUBRICATION COMPONENTS

No.	Parts No.	Parts name	Remarks	Level	Cons	Qty
1	B3502220000	OIL WICK HOLDER				1
2	B3509220000	OIL SPONGE				1
3	B1419026000	OIL WICK PRESSER				3
4	CQ202000000	OIL WICK				1.1
5	BP300000000	VINYL PIPE				0.4
6	B3507280000	OIL FELT				1
7	BP600000000	VINYL PIPE				0.6
8	B3523220000	OIL FELT				1
9	D2112555B00	CORD HOLDER, LARGE				1
10	B3504220000	OIL WICK HOLDER A				1
11	B3505210000	OIL FELT SUPPORTING PLATE				1
12	B3509280000	NEEDLE ROD CRANK LUBRICATING				1
13	CQ252200000	OIL WICK				0.4
14	BP300000000	VINYL PIPE				0.2
15	B3506210000	OIL FELT SUPPORTING PLATE				1
16	B3509280000	NEEDLE ROD CRANK LUBRICATING				1
17	B3518280000	BALANCE LUBRICATING				1
18	CQ202000000	OIL WICK				0.7
19	BP300000000	VINYL PIPE				0.6
20	B3507220000	OIL WICK HOLDER				1
21	B3508220000	OIL TUBE HOLDER				1
22	B3520220000	OIL SPONGE				1
23	BP300000000	VINYL PIPE				0.4
24	CQ202000000	OIL WICK				0.7
25	BP300000000	VINYL PIPE				0.3
26	CQ252200000	OIL WICK				0.5
27	BP300000000	VINYL PIPE				0.3
28	CQ252200000	OIL WICK				0.6
29	BP500000000	VINYL PIPE				0.2
30	B3522220000	OIL FELT				1
31	B3501210000	OIL GAUGE				2
32	B3507210000	OIL FELT				1
33	B3518210000	OIL SPONGE				1
34	B3508280000	BALANCE LUBRICATING PLATE				1
35	B3508280000	BALANCE LUBRICATING PLATE				1
36	B3538112000	CORD HOLDER				1
37	D2112555B00	CORD HOLDER, LARGE				1
38	13530209	LUBRICATING OIL WICK STOPPER				1
39	SS6092120SP	SCREW 9/64-40 L=21.2				1
40	SS6092120SP	SCREW 9/64-40 L=21.2				1
41	SS6111140SP	SCREW 11/64-40 L=11				1
42	SS7110710SP	SCREW 11/64-40 L=7				1
43	SS7110710SP	SCREW 11/64-40 L=7				2
44	SS7110710SP	SCREW 11/64-40 L=7				2
45	SS7110710SP	SCREW 11/64-40 L=7				1
46	SS7110710SP	SCREW 11/64-40 L=7				2
47	SS7110710SP	SCREW 11/64-40 L=7				1

LUBRICATION COMPONENTS

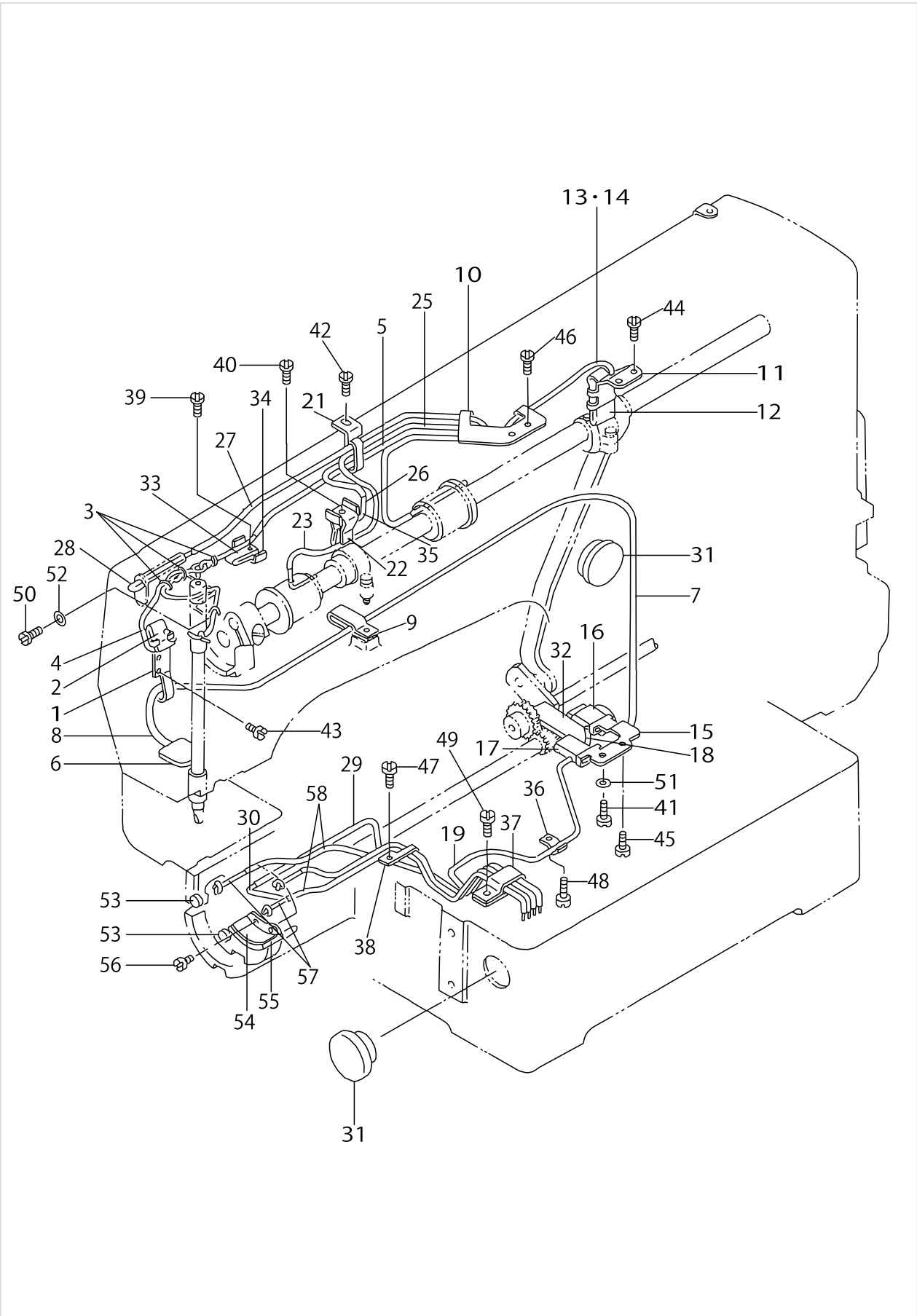

LUBRICATION COMPONENTS

No.	Parts No.	Parts name	Remarks	Level	Cons	Qty
48	SS7110710SP	SCREW 11/64-40 L=7				1
49	SS7110840SP	SCREW 11/64-40 L=7.8				1
50	SS7110710SP	SCREW 11/64-40 L=7				1
51	WP0621016SD	WASHER 6.2X13X1				1
52	WP0450000SD	WASHER 4.5X8X0.5				1
53	13529607	SHUTTLE PACKING				2
54	B3505280000	SHUTTLE LUBRICATING PLATE				1
55	B3504280000	SHUTTLE FELT				1
56	SS6090440SP	SCREW 9/64-40 L= 4.0				2
57	CQ252200000	OIL WICK				1.6
58	BP300000000	VINYL PIPE				1

SENSOR COMPONENTS

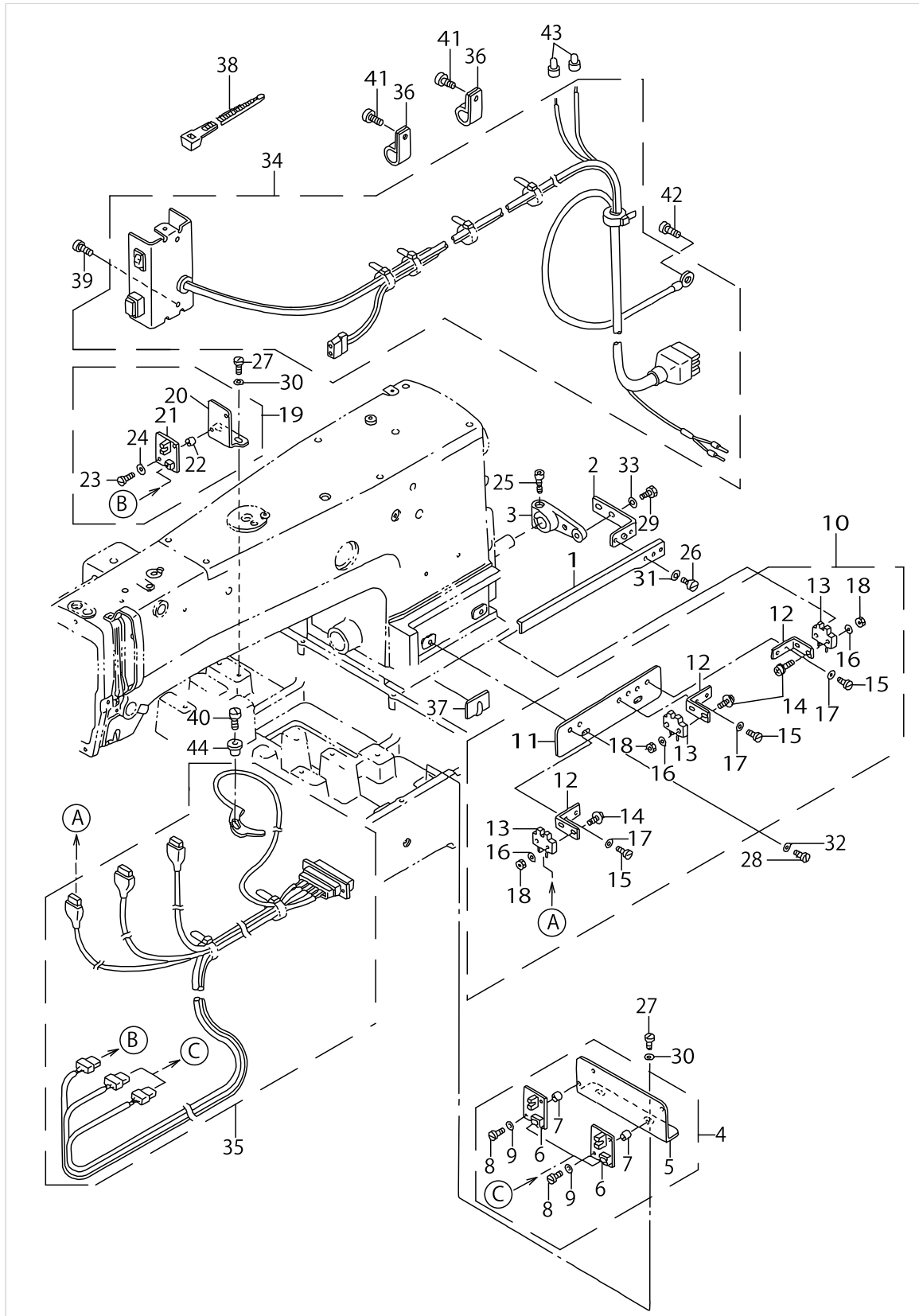

SENSOR COMPONENTS

No.	Parts No.	Parts name	Remarks	Level	Cons	Qty
1	B4008220000	Y SLIT PLATE				1
2	B40092200A0	Y SLIT FIXED PLATE ASM.				1
3	B4010220000	Y SLIT FIXED ARM				1
4	B40042200A0	X SENSOR MOUNTING PLATE A ASM.				1
5	B4004220000	X SENSOR MOUNTING PLATE A		*		1
6	M86065100A0	SENSOR CIRCUIT BOARD ASM. 2		*		2
7	B4011210000	SPACER		*		4
8	SM6031010SC	SCREW M3X0.5 L=10		*		4
9	WP0330501SB	WASHER M3		*		4
10	B40052200A0	Y SENSOR BASE PLATE ASM.				1
11	B4005220000	Y SENSOR BASE PLATE		*		1
12	B4006220000	Y SENSOR FIXED PLATE		*		3
13	HD000120000	PHOTO-MICROSENSOR		*		3
14	SL4031481SF	SCREW M3 L=14		*		6
15	SS7110510SP	SCREW 11/64-40 L=5		*		6
16	WP0330501SB	WASHER M3		*		6
17	WP0450801SD	WASHER 4.5X10.0X0.8		*		6
18	NM6030001SC	NUT M3		*		6
19	B40122200A0	X SENSOR MOUNTING PLATE B ASM.				1
20	B4012220000	X SENSOR MOUNTING PLATE B		*		1
21	M86065100A0	SENSOR CIRCUIT BOARD ASM. 2		*		1
22	B4011210000	SPACER		*		2
23	SM6031010SC	SCREW M3X0.5 L=10		*		2
24	WP0330501SB	WASHER M3		*		2
25	SS6151712TP	SCREW 15/64-28 L=16.5				1
26	SS7110510SP	SCREW 11/64-40 L=5				2
27	SS7110840SP	SCREW 11/64-40 L=7.8				4
28	SS7110840SP	SCREW 11/64-40 L=7.8				2
29	SS7110840SP	SCREW 11/64-40 L=7.8				2
30	WP0450801SD	WASHER 4.5X10.0X0.8				4
31	WP0450801SD	WASHER 4.5X10.0X0.8				2
32	WP0450801SD	WASHER 4.5X10.0X0.8				2
33	WP0450801SD	WASHER 4.5X10.0X0.8				2
34	B41102200AA	SWICH CABLE ASM.				1
35	B41302200A0	FRAME SENSOR CORD ASM.				1
36	HX00123000A	CABLE CLIP				2
37	HX00093000C	CALBE HOLDER				1
38	HX002330000	CLIP				12
39	SS7110710SP	SCREW 11/64-40 L=7				2
40	SS7090850SP	SCREW 9/64-40 L=8				1
41	SS4110815SP	SCREW 11/64-40 L=8				2
42	SS4110815SP	SCREW 11/64-40 L=8				1
43	HP001420000	CONNECTOR				2
44	B2703210000	BUSHING				1

PNEUMATIC COMPONENTS

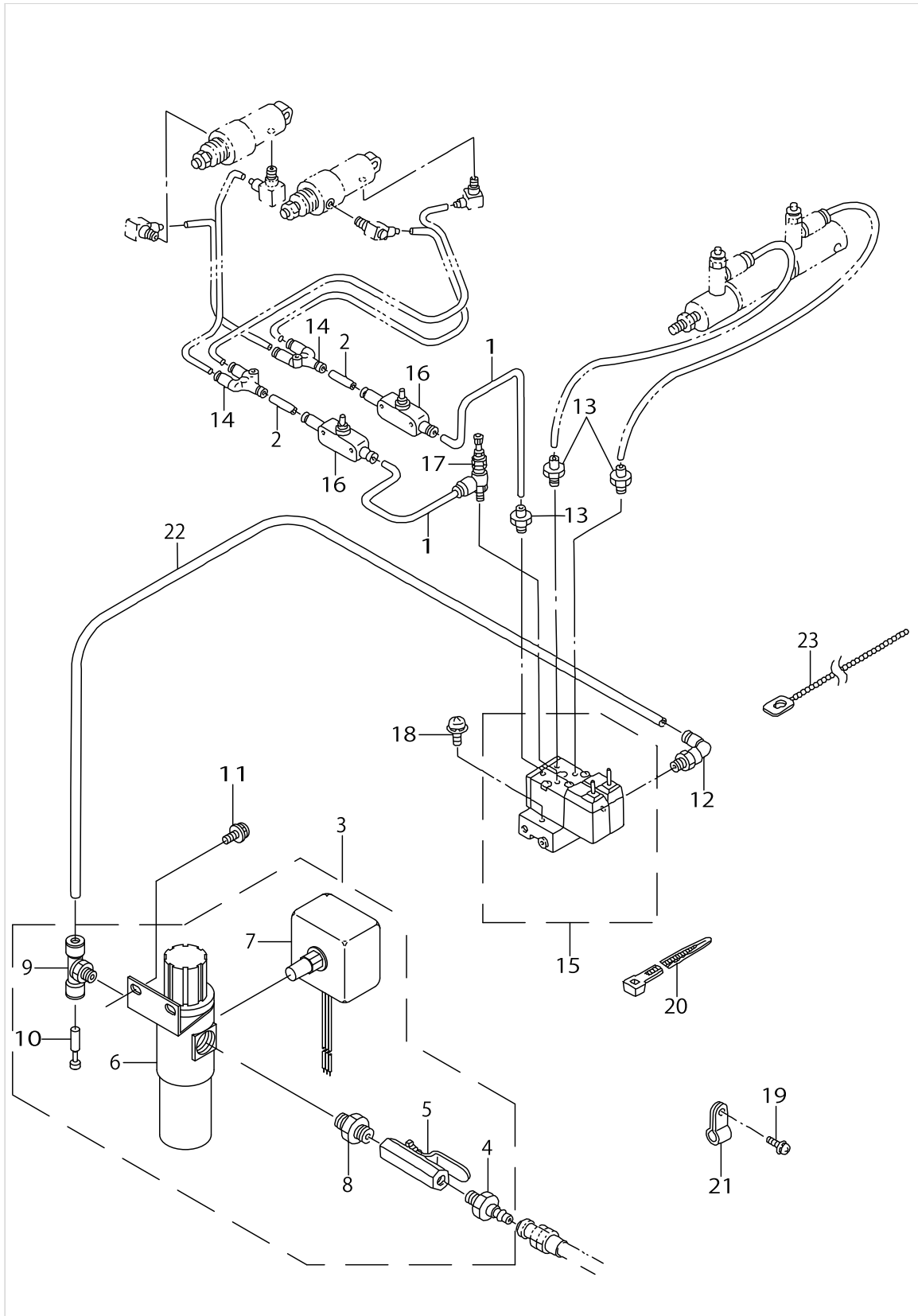

PNEUMATIC COMPONENTS

No.	Parts No.	Parts name	Remarks	Level	Cons	Qty
1	B471022000A	AIR TUBE A D=4				2
2	B471022000B	AIR TUBE B D=4				2
3	B47152200A0	FILTER REGULATOR ASM.				1
4	PJ309005203	QUICK JOINT PLUG		*		1
5	G5430116000	AIR COCK		*		1
6	PF0552040B0	FILTER REGULATOR		*		1
7	PF065206000	AIR PRESSURE SWITCH		*		1
8	PJ030520001	RING JOINT (NIPPLE)		*		1
9	PJ305065202	TEE		*		1
10	PX950009000	PLUG		*		1
11	SL4051091SC	SCREW M5X0.8 L=10				2
12	PJ304065101	ELBOW UNION 6XPT1/8				1
13	PJ032052503	HOSE NIPPLE				3
14	PJ308040002	QUICK COUPLING				2
15	PV0351130A0	SOLENOID VALVE ASM.				1
16	PC012401000	SPEED CONTROLLER				2
17	PF070501000	PRESSURE DECREASING VALVE				1
18	SL4042581SF	SCREW M4 L=25				2
19	SL4040891SC	SCREW M4X8				2
20	EA9500B0100	CABLE BAND				7
21	EA9502B0500	CABLE CLIP				2
22	BT0600401EB	TUBE				1.3
23	HX000220000	BAND				1

TABLE COMPONENTS

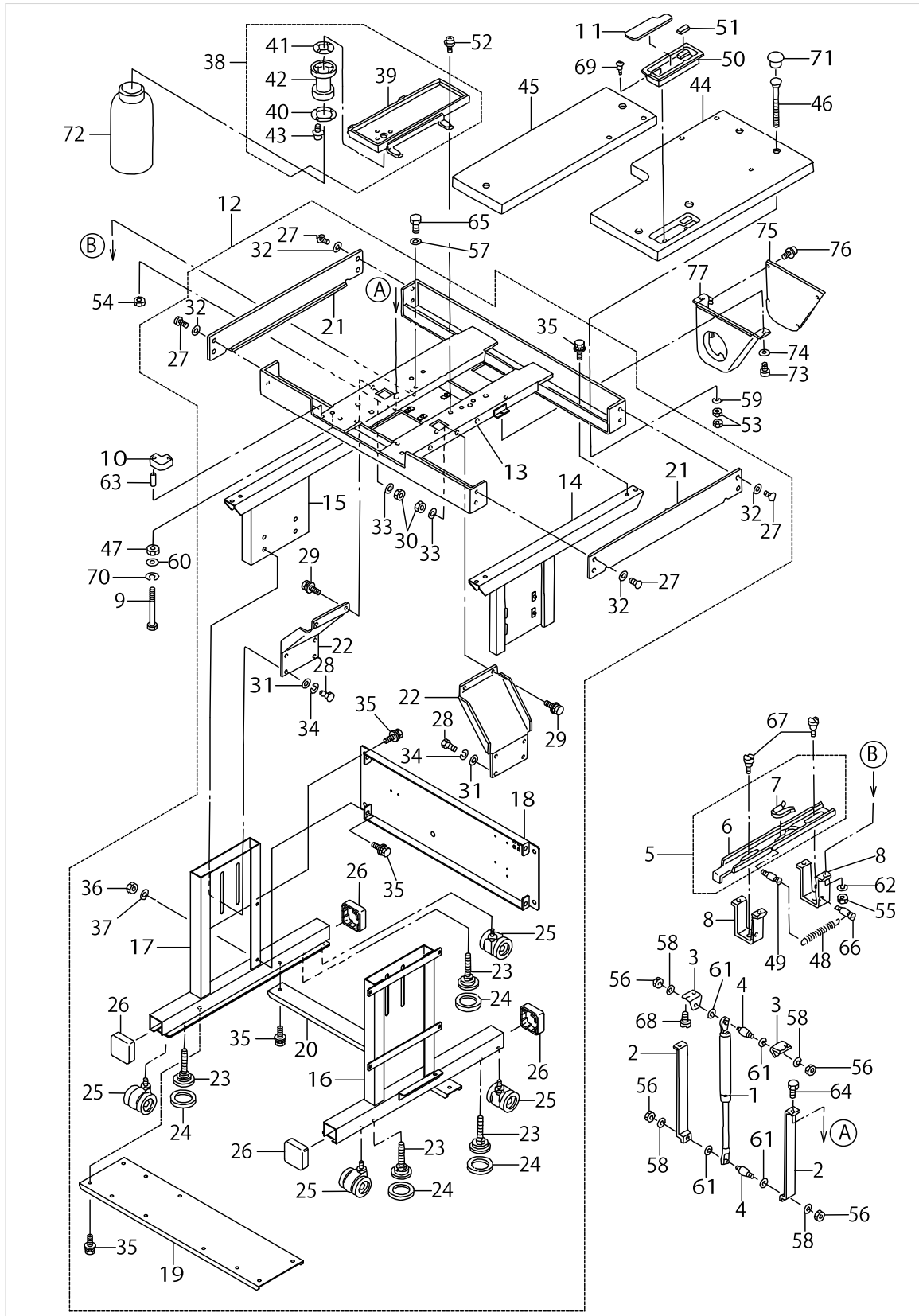

TABLE COMPONENTS

No.	Parts No.	Parts name	Remarks	Level	Cons	Qty
1	B8160220000	GAS SPRING				1
2	B8161220000	LIFTER BRACKET A				2
3	B8162220000	LIFTER BRACKET B				2
4	B8163220000	LIFTER PIVOT PIN				2
5	B81642200A0	LIFTER STOPPER ASM.				1
6	B8164220000	LIFTER STOPPER		*		1
7	B8165220000	LIFTER GROMMET		*		1
8	B8166220000	LIFTER STOPPER HOLDER				2
9	SM9087533SC	SCREW M8 L=75				2
10	B8171220000	RUBBER ABSORBER				3
11	B8173220000	SHEET				1
12	B83012200A0	STAND ASM.				1
13	B8301220000	UPPER STAND		*		1
14	B8302220000	UPPER STAND STRUT, RIGHT		*		1
15	B8303220000	UPPER STAND STRUT, LEFT		*		1
16	B8304220000	LOWER STRUT, RIGHT		*		1
17	B8305220000	LOWER STRUT, LEFT		*		1
18	B8306220000	SIDE STRUT		*		1
19	B8307220000	LOWER STRUT A		*		1
20	B8308220000	LOWER STRUT B		*		1
21	B810322000B	STAND COVER		*		2
22	B8309220000	STAND STAY		*		2
23	B8108220000	ADJUSTING BOLT		*		4
24	B8109220000	RUBBER CAP		*		4
25	B8150220000	CASTER		*		4
26	20243200	STAND CAP, W		*		4
27	SM5051400SC	SCREW M5 L=14		*		8
28	SM9122503SB	SCREW M12 L=25		*		8
29	SL9082093SE	SCREW		*		4
30	NM6080001SC	NUT M8X1.25		*		4
31	WP1302501SC	WASHER 13X24X2.5		*		8
32	WP0561616SC	WASHER 5.6X16X1.6		*		8
33	WP0841601SC	WASHER 8.4X17.4X1.6		*		4
34	WS1253010KN	SPRING WASHER 12.5X21.5X3		*		8
35	SL9082093SE	SCREW		*		22
36	NM6080001SC	NUT M8X1.25		*		2
37	WP0841601SC	WASHER 8.4X17.4X1.6		*		2
38	B81102200A0	OIL PAN ASM.				1
39	B8110220000	OIL PAN		*		1
40	B8111220000	WASHER		*		1
41	B8112220000	OIL SEAL		*		1
42	B8202205000	OIL MANAGEMENT		*		1
43	SL4031481SC	SCREW M3 X 14		*		4
44	B820122000EA	TABLE, RIGHT				1
45	B820122000FA	TABLE (LEFT)				1
46	11571908	BOLT D				5
47	B3505019000	OIL CUP GASKET				2

TABLE COMPONENTS

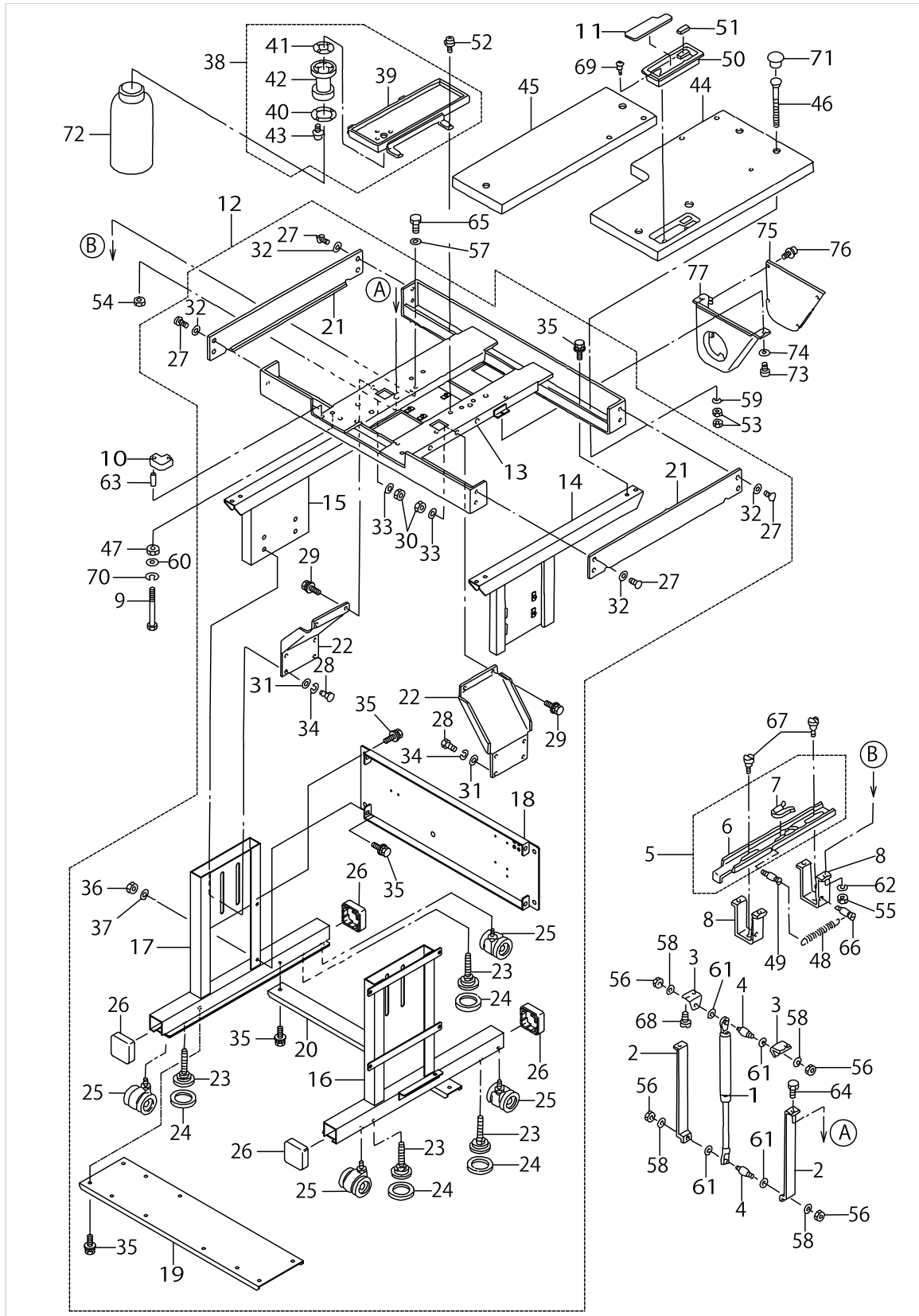
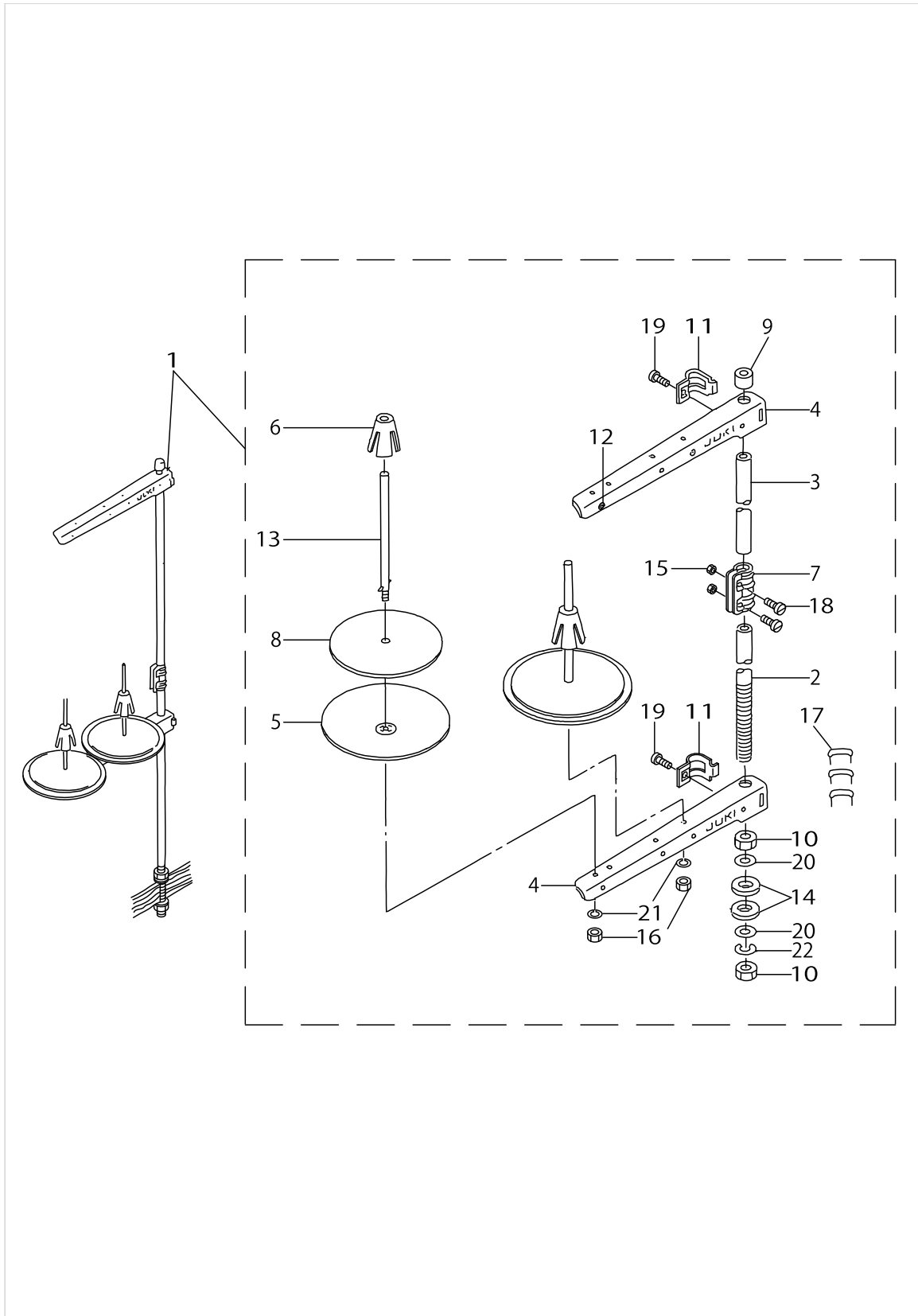

TABLE COMPONENTS

No.	Parts No.	Parts name	Remarks	Level	Cons	Qty
48	B2629980000	SPRING				1
49	B1506352000	TENSION SPRING RACK B				1
50	11150208	CASE				1
51	11150406	FELT				1
52	SL4041091SC	SCREW M4 X 10				4
53	NS6240630SN	NUT 3/8-18				10
54	NM6060002SE	NUT M6				2
55	NM6060002SE	NUT M6				4
56	NM6060002SE	NUT M6				4
57	WP0641601SC	WASHER				4
58	WP0641601SC	WASHER				4
59	WP1021016SD	WASHER				5
60	WP0841601SC	WASHER 8.4X17.4X1.6				2
61	WP0841600SE	WASHER 8,4X15,5X1,6				4
62	WS0610002KN	SPRING WASHER 6.1X12.2X1.5				4
63	PS0400141KH	SPRING PIN 4X14				6
64	SM9061850SC	SCREW M6 L=18				2
65	SM9061850SC	SCREW M6 L=18				4
66	MAT80116S00	SUSPENSION PIN				1
67	SD0800341SP	HINGE SCREW D=8 H=3.4				2
68	SS9151120CP	SCREW 15/64-28 L=11				4
69	SK3381300SC	WOOD SCREW D=3.8 L=13				2
70	WS0820002KN	SPRING WASHER M8				2
71	HX00326000B	BUSH				5
72	B9121012000	OIL CAN				1
73	SL4051241SE	SCREW	FOR 220CSS-5000(FOR EXPORT. JE)			2
74	WP0561616SC	WASHER 5.6X16X1.6	FOR 220CSS-5000(FOR EXPORT. JE)			2
75	B821121000B	MOTOR PULLEY COVER (B)	FOR 220CSS-5000(FOR EXPORT. JE)			1
76	SL4040691SC	SCREW M4 X 6	FOR 220CSS-5000(FOR EXPORT. JE)			6
77	B821021000B	MOTOR PULLEY COVER (A)	FOR 220CSS-5000(FOR EXPORT. JE)			1

THREAD STAND COMPONENTS



THREAD STAND COMPONENTS

No.	Parts No.	Parts name	Remarks	Level	Cons	Qty
1	11183654	THREAD STAND ASM.				1
2	11183605	SPOOL REST ROD, LOWER		*		1
3	11183704	SPOOL REST ROD, UPPER		*		1
4	11183803	THREAD GUIDE		*		2
5	11183902	SPOOL REST		*		2
6	11184009	SPOOL RETAINER		*		2
7	11184207	SPOOL REST ROD JOINT		*		1
8	B3311012000	SPOOL REST CUSHION		*		2
9	11184108	SPOOL REST ROD RUBBER CAP		*		1
10	B3317704000	NUT C15		*		2
11	11184306	THRED GUIDE ARM JOINT		*		2
12	B3319704L00	THREAD GUIDE		*		2
13	B3320704L00A	SPOOL PIN		*		2
14	D3310555D00	RUBBER WASHER		*		2
15	NM6050001SE	NUT M5X0.8		*		2
16	NM6050001SE	NUT M5X0.8		*		2
17	MAO11532000	CORD STAPLE		*		3
18	SM4051405SE	SCREW M5X0.8 L=14		*		2
19	SM6061610SC	SCREW M6 L=16		*		2
20	WP1702600S0	WASHER 17X30X2.6		*		2
21	WS0510002KN	SPRING WASHER		*		2
22	WS1643202KR	SPRING WASHER		*		1

CONTROL BOX COMPONENTS

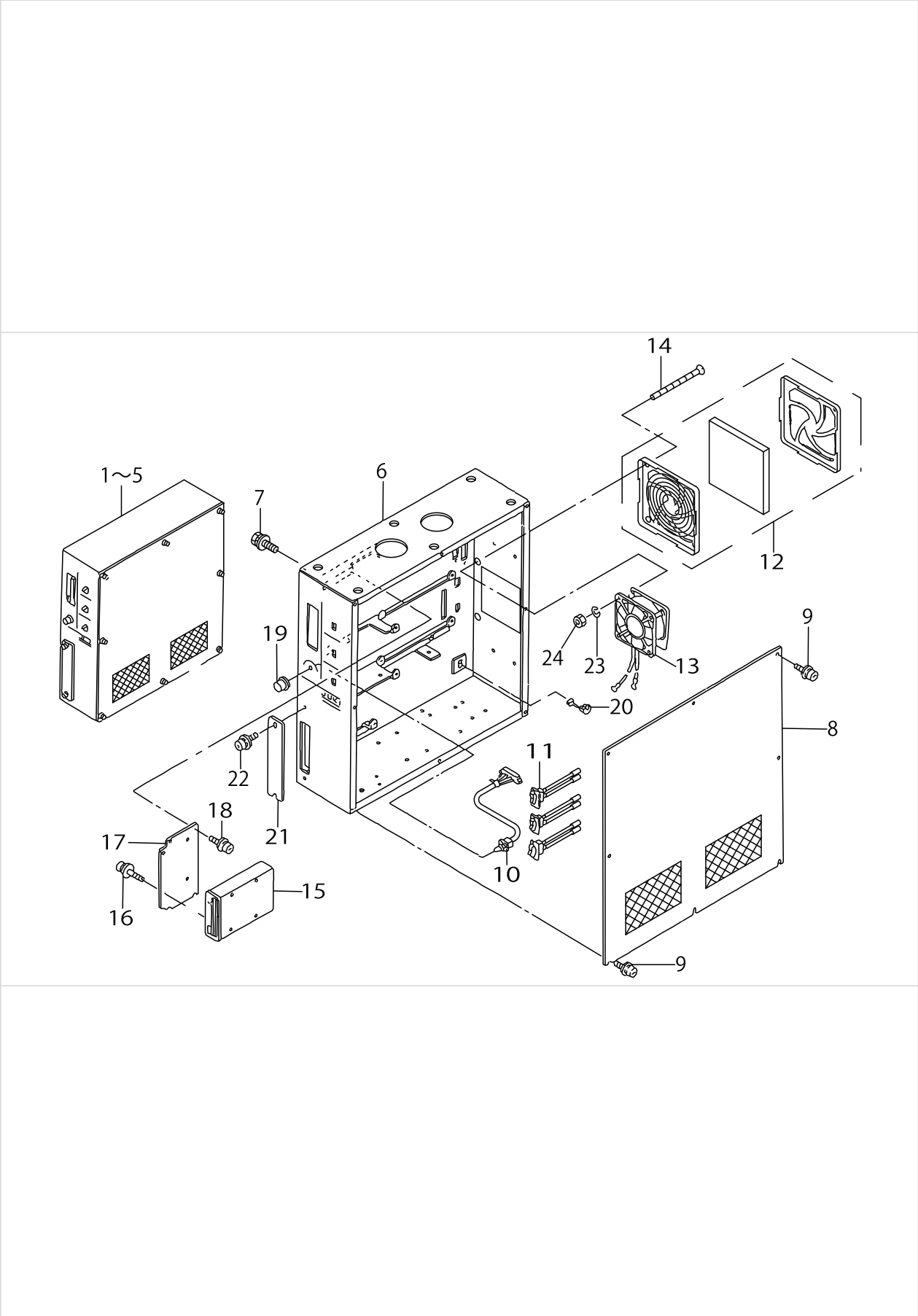

CONTROL BOX COMPONENTS

No.	Parts No.	Parts name	Remarks	Level	Cons	Qty
1	M8510518BA0A	CONTROL BOX ASM.	FOR 100V(FOR DOMESTIC USE)			1
2	M8510518DA0A	CONTROL BOX ASM.	FOR 100V(FOR EXPORT)			1
3	M8510518AA0A	CONTROL BOX ASM.	FOR 200V(FOR DOMESTIC USE)			1
4	M8510518CA0A	CONTROL BOX ASM.	FOR 200V(FOR EXPORT)			1
5	M8510518EA0A	CONTROL BOX ASM.	FOR 380V(FOR EXPORT)			1
6	M1001518000	CONTROL BOX				1
7	SL9082093SE	SCREW				5
8	M10025130AA	CONTROL BOX COVER ASM.				1
9	SL4041091SC	SCREW M4 X 10				8
10	M85325180A0	SPEED VOLUME ASM.				1
11	M85315180A0	SEESAW SWITCH ASM.				3
12	HM000630010	FILTER				1
13	M85785180A0	FAN ASM.				1
14	SM1046051SF	SCREW M4 L=60				4
15	HX002980000	FLOPPY DISK DRIVER				1
16	SL4030691SC	SCREW M3X6				4
17	M1011512000	FDD INSTALLING PLATE				1
18	SL4041091SC	SCREW M4 X 10				4
19	HX00114000B	KNOB				1
20	HX000210000	CORD BUSHING				1
21	M1010510000	PLATE				1
22	SL4041091SC	SCREW M4 X 10				2
23	WS0410002KN	SPRING WASHER				4
24	NM6040001SB	WIND ADJUSTING PLATE ATTACHING				4

OPERATION BOX COMPONENTS

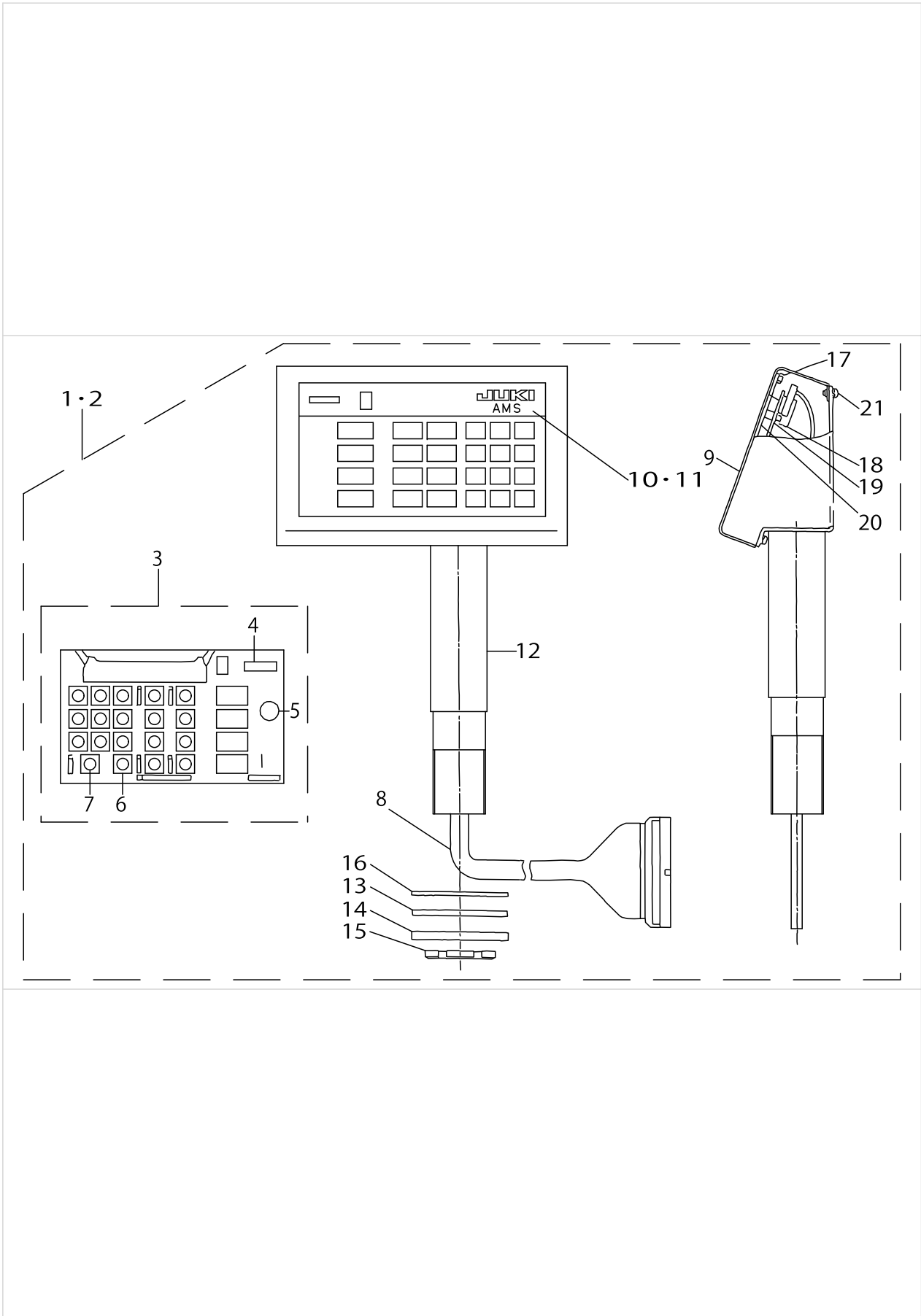

OPERATION BOX COMPONENTS

No.	Parts No.	Parts name	Remarks	Level	Cons	Qty
1	M8570518AA0	OPERATION BOX A ASM.	FOR DOMESTIC USE			1
2	M8570518BA0	OPERATION BOX B ASM.	FOR EXPORT			1
3	M8670510AA0	OPERATION PCB A ASM.		*		1
4	HG003280000	DIODE (LD701VR)		*		1
5	HX001530000	BUZZER 1		*		1
6	HG003290000	DIODE (LA301VLL)		*		13
7	HA001410000	KEY SWITCH		*		19
8	M90505180A0	SIGNALING CORD ASM.		*		1
9	M1081518000	OPERATION BOX COVER		*		1
10	M300451300G	PANEL SHEET(DOMESTIC)	FOR DOMESTIC USE	*		1
11	M3010518000	OPERATION PANEL SHEET	FOR EXPORT	*		1
12	M85715180A0	OPERATION BOX STAND ASM.		*		1
13	M1076510000	VIBRATION-PROOF RUBBER PAD		*		1
14	M1077510000	WASHER		*		1
15	M1078510000	NUT		*		1
16	M1075518000	WASHER		*		1
17	NM6030001SC	NUT M3		*		4
18	NM6030001SC	NUT M3		*		6
19	WP0320500SC	WASHER M3		*		6
20	M1082518000	OPERATION BOX BASE COVER		*		1
21	SL4030681SC	SCREW M3 L=6		*		4

CIRCUIT BOARD COMPONENTS

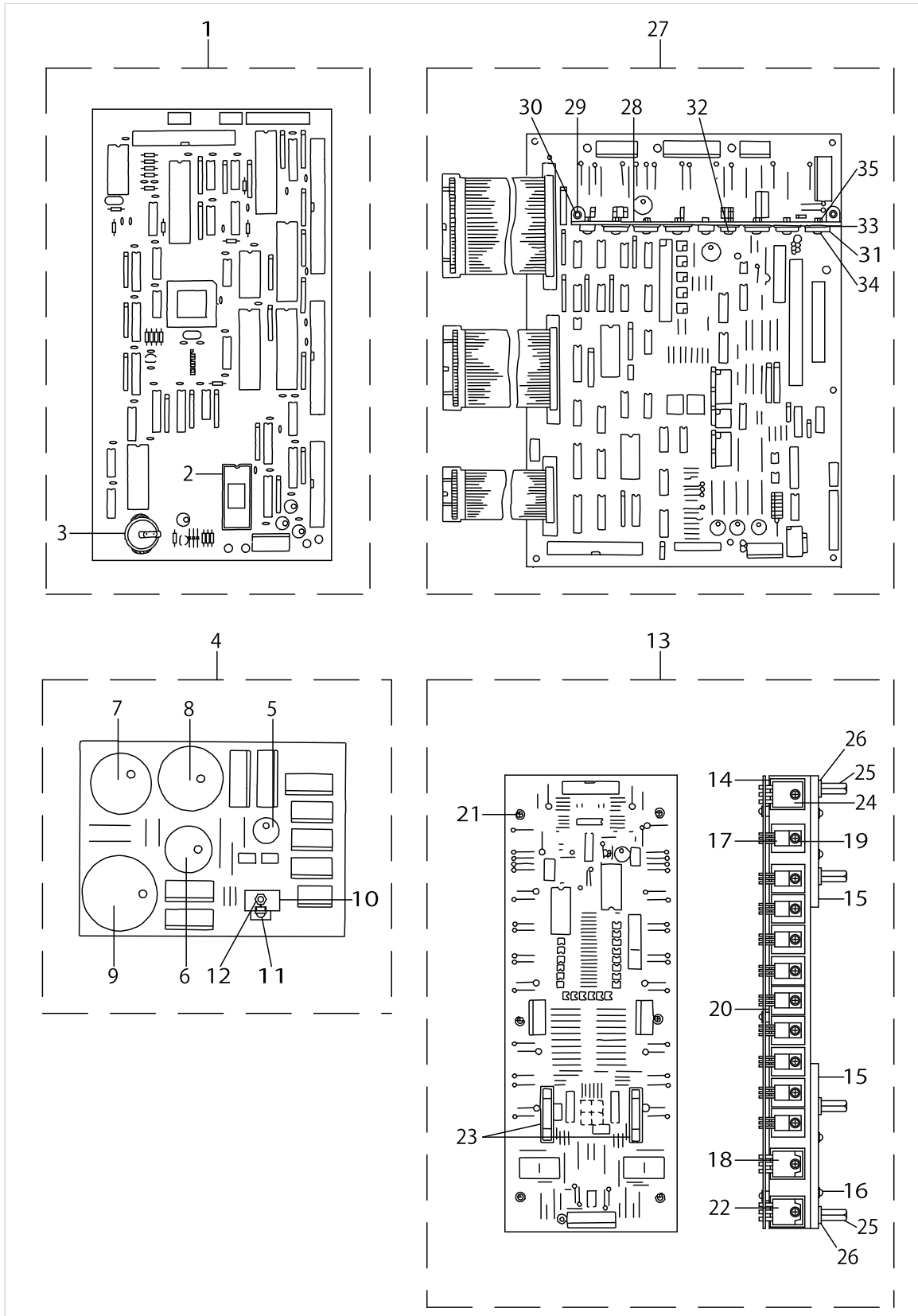

CIRCUIT BOARD COMPONENTS

No.	Parts No.	Parts name	Remarks	Level	Cons	Qty
1	M8601518AA0	CPU BOARD A ASM.				1
2	HL014530001	IC		*		1
3	HX004140000	BATTERY		*		1
4	M86045180A0	POWER BOARD ASM.				1
5	HC010802210	CAPACITOR 220MF		*		1
6	HC018701020	CAPACITOR 1000MF		*		1
7	HC018803320	CAPACITOR 3300MF		*		1
8	HC034205620	ELECTROLYSIS ALUMINUM 100V		*		1
9	HC018801030	CAPACITOR 10000MF		*		1
10	GBR01713000	TRANSISTOR FIN B		*		1
11	SL4030881SC	SCREW M3X8		*		2
12	NM6030001SC	NUT M3		*		2
13	M8603518AA0	PMDC BOARD A ASM.				1
14	M1003518000	HEAT SINK PLATE, C		*		2
15	M1005518000	HEAT SINK PLATE,E		*		2
16	SL4031481SC	SCREW M3 X 14		*		8
17	HT002460000	TRANSISTOR (2SD1162)		*		20
18	HG003270000	DIODE ARRAY		*		2
19	SL4031481SC	SCREW M3 X 14		*		26
20	M9609171000	SPACER		*		6
21	SL4031481SC	SCREW M3 X 14		*		6
22	HT003330000	FET (2SJ113)		*		2
23	E9628252000	FUSE 7A		*		2
24	HT002570000	TRANSISTOR 2SD1296		*		2
25	HX00339000C	PARTS		*		8
26	WP0482086SD	WASHER 4.8X11.5X2.0		*		8
27	M86025120A0	I/F CIRCUIT BOARD ASM.				1
28	M1021512000	RADIATOR PLATE A		*		1
29	SL4031281SC	SCREW M3 L=12		*		2
30	NM6030001SC	NUT M3		*		2
31	HT002570000	TRANSISTOR 2SD1296		*		6
32	HL006390000	IC (UPC14324H)		*		1
33	HX001970000	INSULATE PLATE		*		7
34	SL4031281SC	SCREW M3 L=12		*		9
35	NM6030001SC	NUT M3		*		9

POWER SUPPLY & CORD COMPONENTS

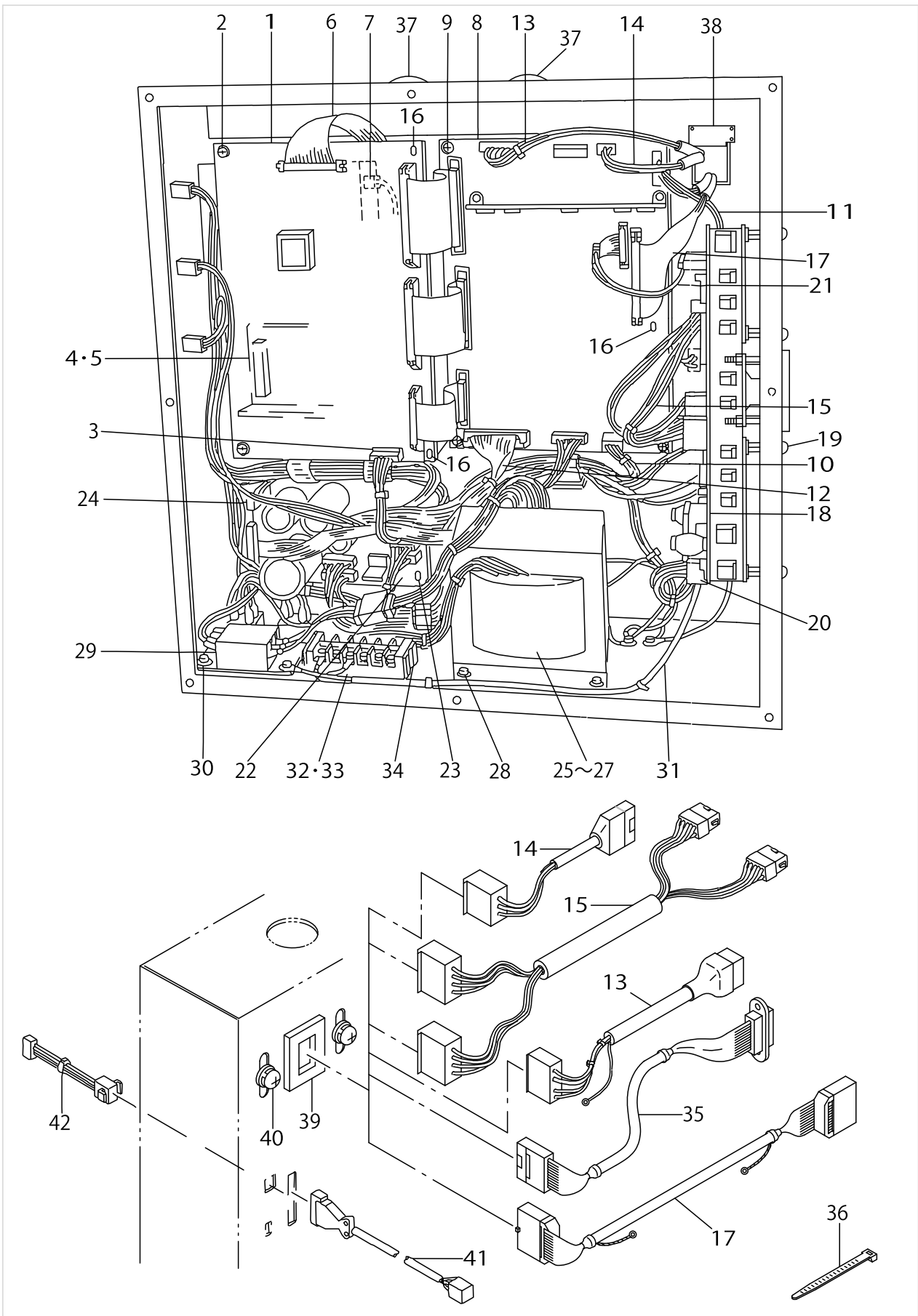

POWER SUPPLY & CORD COMPONENTS

No.	Parts No.	Parts name	Remarks	Level	Cons	Qty
1	M8601518AA0	CPU BOARD A ASM.				1
2	SL4030891SC	SCREW M3X8				2
3	M85545120A0	CPU POWER SOURCE CORD ASM.				1
4	M85115120A0	REGULATOR ASM.				1
5	SL4030891SC	SCREW M3X8				2
6	M85465120A0	FDD SIGNALING CORD ASM.				1
7	M85475120A0	FDD POWER SOURCE CORD ASM.				1
8	M86025120A0	I/F CIRCUIT BOARD ASM.				1
9	SL4030891SC	SCREW M3X8				6
10	M85565120A0	I/F CONTROL POWER CORD ASM.				1
11	M85575120A0	I/F DRIVING POWER CORD ASM.				1
12	M85515120A0	PGM-1 SIGNALING CORD ASM.				1
13	M90435180A0	SOLENOID CORD ASM.				1
14	M90445180A0	CLUTCH BRAKE CORD ASM.				1
15	M90425180A0	PULSE MOTOR CORD ASM.				1
16	HX004150000	BOARD SUPPORT				3
17	M90505180A0	SIGNALING CORD ASM.				1
18	M86035180A0	PMDC BOARD ASM.				1
19	SL4040881SF	SCREW M4 L=8				8
20	M85555120A0	PMDC POWER SOURCE CORD ASM.				1
21	M85435120A0	PMDC SIGNALING CORD ASM.				1
22	M86045180A0	POWER BOARD ASM.				1
23	HX00269000A	PCB SUPPORT				4
24	M85525120A0	PGM-1 POWER SOURCE CORD ASM.				1
25	M8513518AA0	POWER TRANS A ASM.	FOR 190V~250V			1
26	M8513518BA0	POWER TRANS B ASM.	FOR 100V~130V			1
27	M8513518CA0	POWER TRANS C ASM.	FOR 220V~440V(FOR EXPORT)			1
28	SL4051091SC	SCREW M5X0.8 L=10				4
29	M85145120A0	RECTIFIER ASM.				1
30	SL4041091SC	SCREW M4 X 10				3
31	M8561510CA0	AC INPUT POWER CABLE ASM.				1
32	HK045550060	TERMINAL	FOR 100V~130V, 190V~250V			1
33	HK045550080	TERMINAL	FOR 220V~440V(FOR EXPORT)			1
34	SL4042091SC	SCREW M4X0.7 L=20				2
35	M90415180A0	SENSOR SIGNALING CORD ASM.				1
36	HX002920000	BAND				1
37	HX00326000F	BUSH				2
38	17845009	CORD FITTING PLATE				1
39	HX004070000	BUSH				1
40	SL4041091SC	SCREW M4 X 10				2
41	M85925120A0	AIR VALVE TRUNK CORD ASM.				1
42	M85615120A0	PEDAL SWITCH CORD ASM.				1

PEDAL & ELECTRIC EQUIPMENT ACCESSORIE PART COMPONENTS

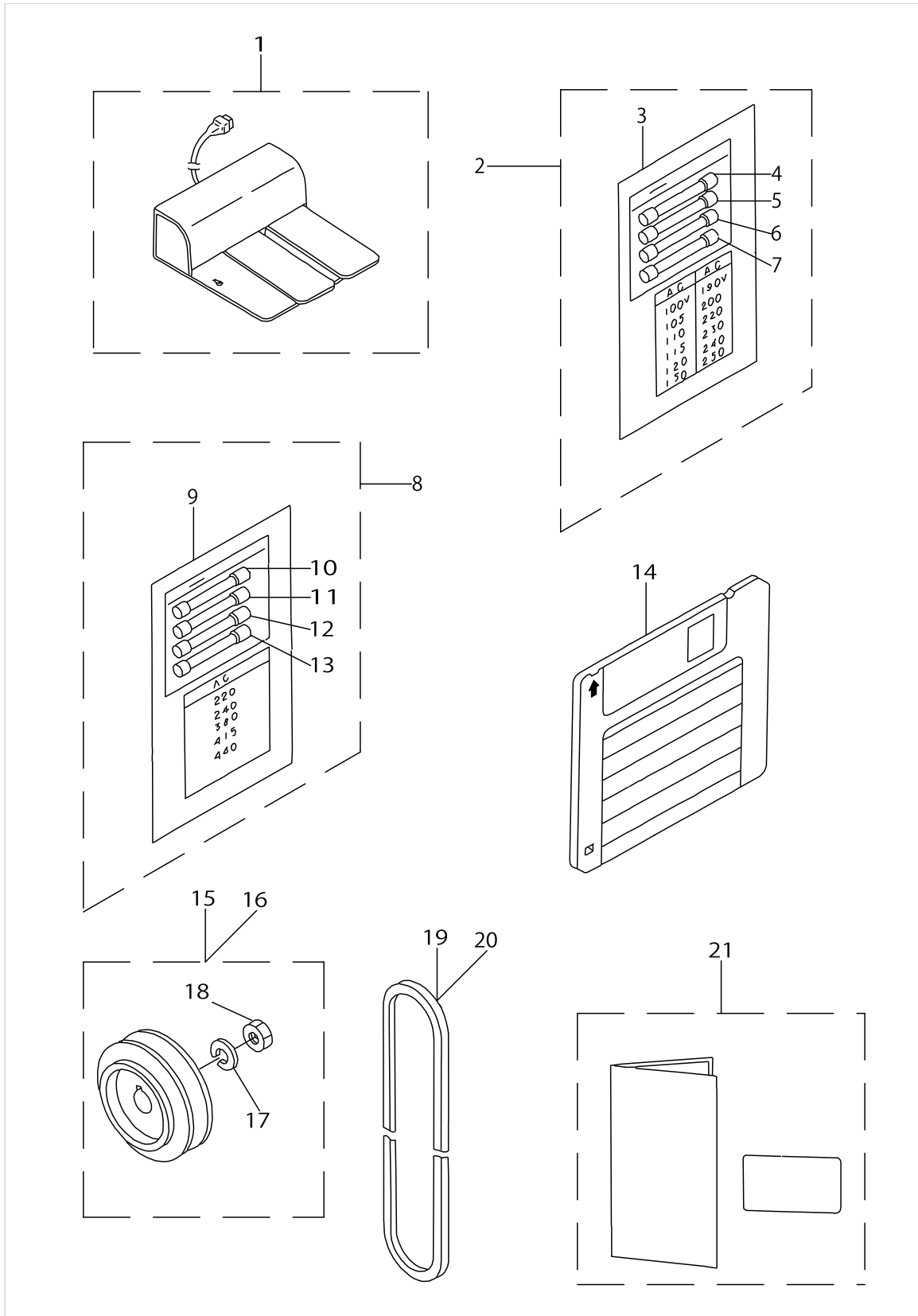

PEDAL & ELECTRIC EQUIPMENT ACCESSORIE PART COMPONENTS

No.	Parts No.	Parts name	Remarks	Level	Cons	Qty
1	M85905130AA	PEDAL SWITCH ASM.				1
2	M85995120A0	ACCESSORIES ASM.				1
3	M3010110B00	VOLTAGE SHEET		*		1
4	E9628252000	FUSE 7A		*		1
5	HF001400700	TIME LAG FUSE 7A		*		1
6	E9611601000	FUSE 1A		*		1
7	E8523304000	FUSE 10A		*		1
8	M85995120AB	ACCESSORIES B ASM.	FOR 220V~440V(FOR EXPORT)			1
9	M300451100B	VOLTAGE DISPLAY NOTE		*		1
10	E9628252000	FUSE 7A		*		1
11	HF001400700	TIME LAG FUSE 7A		*		1
12	E9611601000	FUSE 1A		*		1
13	E8523304000	FUSE 10A		*		1
14	M9650513000	FLOPPY DISK A	FLOPPY DISK IN SERVICE PATTERN			1
15	MTSP00950A0	MOTOR PULLEY ASM. P.C.D. 95	FOR 50HZ			1
16	MTSP00800A0	MOTOR PULLEY ASM. P.C.D. 80	FOR 60HZ			1
17	WS1002560KR	SPRING WASHER 10X18X2.5		*		1
18	NM6550815SF	NUT		*		1
19	MTJVM004700	V BELT 47 INCHES				1
20	MTJVM004800	V BELT 48 INCHES	FOR SINGLE PHASE 50HZ			1
21	M30045180A0	OPERATION PANEL SHEET ASM.	FOR EXPORT			1

ACCESSORIE PART COMPONENTS

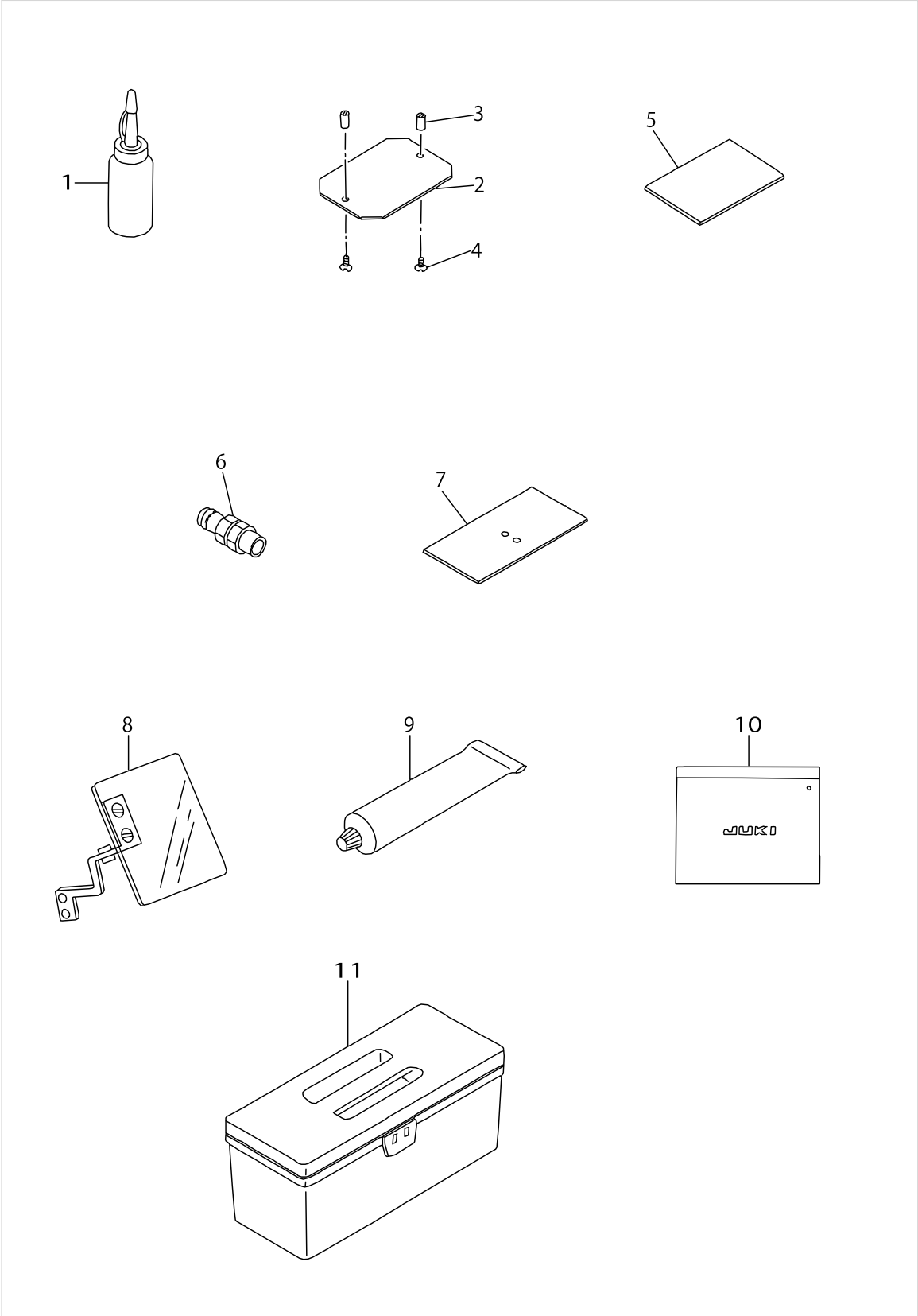

ACCESSORIE PART COMPONENTS

No.	Parts No.	Parts name	Remarks	Level	Cons	Qty
1	B91212200A0	OILER (CONTAINING NO.2 OIL)				1
2	B2557220000	PLASTIC BLANK PLATE				2
3	B2559220000	HINGE PIN				4
4	SS1090510SP	SCREW 9/64-40 L=5				4
5	B2591220000	RUBBER SHEET				2
6	PJ309120001	QUICK COUPLING, SOCKET				1
7	B1170220000	AUXILIARY COVER SHEET				2
8	B31012800A0	SAFTY PLATE ASM.				1
9	13525506	GREASE TUBE				1
10	B9101552000	ACCESSORY BOX				1
11	B8601WP10A0	TOOL BOX ASM.				1

OPTIONAL COMPONENTS

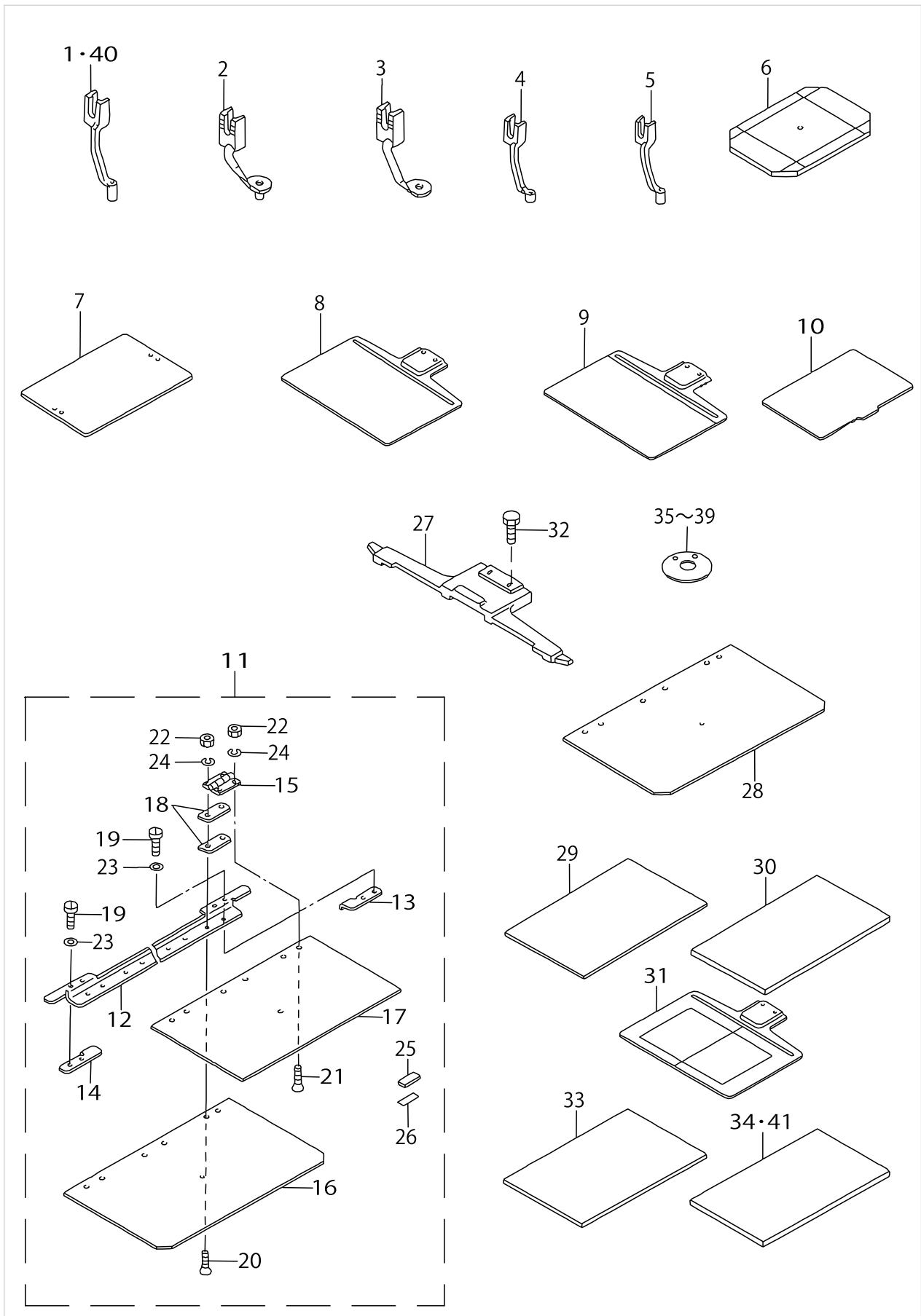

OPTIONAL COMPONENTS

No.	Parts No.	Parts name	Remarks	Level	Cons	Qty
1	B160122000B	INTERMEDIATE PRESSER B				1
2	B160122000C	INTERMEDIATE PRESSER C				1
3	B160122000D	INTERMEDIATE PRESSER D				1
4	B160122000E	INNER PRESSER (E)				1
5	B160122000F	INNER PRESSER (F)				1
6	B2593220000	GAUGE				1
7	B25532200Y0	FEEDING FRAME BLANK				1
8	B25562200YB	FEED PLATE BLANK				1
9	B25562200Y0	FEED PLATE BLANK				1
10	B259122000B	SPONGE SHEET				1
11	B25822200A0	CASSETTE HOLDER ASSEMBLY				1
12	B2582220000	CASSETTE HOLDER ASSEMBLY		*		1
13	B2595210000	PLACE DECISION BOARD RIGHT		*		1
14	B2596210000	PLACE DECISION BOARD LEFT		*		1
15	B2597210000	CASSETTE HOLDER HINGE		*		3
16	B2583220000	CASSETTE PRESSER LOWER BOARD		*		1
17	B2584220000	CASSETTE PRESSER UPPER BOARD		*		1
18	B2589210000	CASSETTE PRESSER SPACER		*		6
19	SM5030655SP	SCREW		*		4
20	SM1031001SC	SCREW M3X0.5 L=10		*		6
21	SM1030601SC	SCREW M3 X 8		*		6
22	NM60300000A	NUT M3X0.5		*		12
23	WP0320501SC	WASHER M3		*		4
24	WS0310002KN	SPRING WASHER M3		*		12
25	B2585220000	CASSETTE PRESSER RUBBER MAGNET		*		2
26	B2586220000	MAGNET BOARD		*		2
27	B2581220000	CASSETTE HOLDER FIXING PLATE				1
28	B2589220000	CASSETTE HOLDER LOWER PLATE B				1
29	B2587220000	WORK CLAMP PAPER MATERIAL (A)				1
30	B2588220000	WORK CLAMP PAPER MATERIAL (B)				1
31	B2594220000	STANDARD LOWER PLATE				1
32	SS9151440CP	SCREW 15/64-28 L=14				2
33	B259522000A	PRESSER CLOTH SHEET				1
34	B259522000B	PRESSER CLOTH SHEET B				1
35	B242621000B	NEEDLE HOLE GUIDE D=2.0				1
36	B242621000C	NEEDLE HOLE GUIDE D=1.6				1
37	B242621000D	NEEDLE HOLE GUIDE D=2.4				1
38	B242621000F	CIRCLE 3 NEEDLE HOLE GUIDE				1
39	B242621000G	NEEDLE HOLE GUIDE D=3				1
40	B160122000G	INNER PRESSER G				1
41	B259522000C	PRESSER CLOTH SHEET				1

HOW TO MAKE USE OF THIS PARTS LIST

1.As to "#01" and "#02" refer to the "Note" given at the bottom of the respective pages.

2.Codes on the "Qty" column

- Each numeral indicates the number of parts required.
- "0.1" and "2.5" indicate the length (in meters) of the respective parts.

3.Parentheses mean that the corresponding part is a subpart that constructs an assembly part.

4.Dotted lines on the Figures indicate assembly parts.

1. リストページの# 0 1、# 0 2の印は、ページ下の"注記"の説明を参照下さい。
2. 数量欄の数字は、個数を表し、0. 1、2. 5等の数値は、長さ（単位メートル）を表します。
3. 数量欄の（ ）は、組部品を構成している子部品であることを意味します。
4. イラストページの-----枠は、組構成であることを意味します。

NUMERICAL INDEX OF PARTS

PART NO	PAGE	REF NO.	PART NO	PAGE	REF NO.	PART NO	PAGE	REF NO.
10007003	2	28	B1115220000	8	4	B1404280000	10	31
11071701	14	30	B1115232000	2	77	B1405012000	4	69
11150208	46	50	B1115232000	4	77	B1405210000	10	25
11150406	46	51	B11152320A0	2	75	B1406210000	12	48
11183605	48	2	B11152320A0	4	75	B14115520A0	10	28
11183654	48	1	B1117220000	2	2	B1411804A00	10	40~43
11183704	48	3	B111822000A	6	6	B1411804A00	18	29~32
11183803	48	4	B1120220000	8	5	B1411804B00	10	40~43
11183902	48	5	B1121220000	6	7	B1411804B00	18	29~32
11184009	48	6	B112222000B	2	3	B1411804C00	10	40~43
11184108	48	9	B112322000B	2	4	B1411804C00	18	29~32
11184207	48	7	B1123280000	2	40~43	B1411804D00	10	40~43
11184306	48	11	B1124220000	2	5	B1411804D00	18	29~32
11571908	44	46	B1124280000	2	40~43	B1414232000	10	26
13501309	2	47	B1125220000	2	6	B1419026000	36	3
13501408	4	48	B1125280000	2	40~43	B1502220000	6	15
13501705	4	49	B1126210000	2	36~39	B1506352000	46	49
13508205	18	33	B1126552000	2	44	B1509227000	14	28
13508403	18	8	B1127280000	2	40~43	B1510227000	14	29
13508700	18	35	B112821000B	2	36~39	B1601220000	14	1
13508809	18	36	B1150220000	8	6	B160122000B	62	1·40
13508908	18	37	B1151220000	8	7	B160122000C	62	2
13513205	24	12	B1152220000	8	8	B160122000D	62	3
13513304	24	13	B11532200A0	8	9	B160122000E	62	4
13525506	60	9	B115822000B	8	10	B160122000F	62	5
13529607	38	53	B1159220A00	8	11	B160122000G	62	1·40
13530209	36	38	B1161220B00	30	7	B1602220000	14	2
13816608	2	36~39	B1170220000	6	8	B1603220000	14	3
13816855	18	34	B1170220000	60	7	B1604220000	14	4
13817408	22	8	B1178191000	2	46	B1605220000	14	5
13817457	22	1	B1201220000	10	1	B1606220000	14	6
17845009	56	38	B1202210000	10	7	B1608220000	14	7
20243200	44	26	B1203280000	10	30	B1609220000	14	8
B110422000B	2	8	B12042100A0	10	8	B1610220000	14	9
B11042200AB	2	7	B12052100AA	10	17	B1611220000	14	10
B110522000A	2	1	B12052100BA	10	16	B1611224000	16	48
B110622000B	8	1	B1206210000	10	9	B1612220000	14	11
B110722000A	8	2	B1207205000	10	11	B1613220000	14	12
B1108220000	6	1	B12082100A0	10	19	B1614220000	14	13
B1109220000	6	2	B12092200A0	10	2	B1615220000	14	14
B111022000A	6	3	B12102200A0	10	4	B1615224000	16	50
B1111220000A	8	3	B1223771000	10	47	B1616220000	14	15
B1111232000	2	36~39	B1401210000	10	23	B1620220000	14	16
B1112220000	6	4	B1402280000	10	24	B1620224000	16	56
B1113220000	6	5	B1403280000	10	27	B1621220000	14	17

NUMERICAL INDEX OF PARTS

PART NO	PAGE	REF NO.	PART NO	PAGE	REF NO.	PART NO	PAGE	REF NO.
B1621224000	16	51	B2104220000	22	19	B242328000C	20	65~67
B1622224000	16	52	B2106220000	22	20	B2424210000	20	75
B16242200A0	14	21	B2107210000	22	21	B24252200AB	20	55-56
B1625220000	14	22	B2301210000	24	7	B2425224000	20	74
B1625224000	16	54	B23012100A0	24	6	B24252240A0	20	55-56
B1626220000	14	18	B23022050A0	22	2	B242621000A	20	57
B1626220000	32	40	B2302210000	24	8	B242621000B	20	58
B1627220000	14	19	B2302280000	22	4	B242621000B	62	35~39
B1628220000	14	20	B2303280000	22	15	B242621000C	62	35~39
B1629224000	16	49	B23042200A0	24	1	B242621000D	62	35~39
B1802210000	18	14	B2305210000	24	5	B242621000F	62	35~39
B18042800A0	18	19	B2306220000	24	2	B242621000G	62	35~39
B1805205000	18	9	B2307220000	24	3	B2501220000	28	3
B1805980000	18	15	B2308220000	24	4	B2501220AA0	28	2
B18112200AA	18	1	B2310220000	24	21	B2501220AB0	28	1
B1812205000	18	10	B2311220000	24	22	B2502220000	28	4
B1813980000	18	16	B2311220000	30	25	B2503220000	28	5
B1814980000	18	17	B2312220000	12	54	B2504220000A	28	21
B1815980000	18	18	B2313280000	22	3	B2505220000A	28	22
B1816280000	32	45	B2401205000	12	56	B2506220000B	28	23
B18172050A0	18	11	B2402220000	24	20	B2507220000	28	6
B18172050AB	18	3	B24022200A0	24	19	B2508220000	28	7
B1818205000	18	12	B2403210000	24	23	B2509229000	28	24
B181820500B	18	4	B2404220000	24	28	B2510220000	30	1
B1819280000	18	21	B24042200A0	24	27	B2511220000	30	2
B1820280000	18	22	B2405210000	24	30	B2512220A00	28	8
B1821280000	18	23	B2406210000	24	31	B2513220A00	28	25
B1823280000	18	24	B2407210000	24	32	B2515220000	28	26
B18282050A0	18	13	B2408210000	24	44	B2517220A00	30	8
B1831220000	18	6	B2409210000	24	42	B2519220000	28	9
B1832220000	18	7	B2410220000	24	41	B252022000A	28	10
B1901280000	10	32	B24102200A0	24	40	B252022000B	28	11
B19012800B0	10	29	B2411210000	24	33	B2521220000	28	12
B1902280000	10	33	B2412220000	24	18	B252222000C	28	14
B1903280000	10	34	B2413220000	24	29	B25222200AA	28	13
B1903552000	10	35	B2414210000	24	45	B2523220000A	30	9
B1904280000	10	46	B24142800A0	20	63	B25242200A0	30	3
B1905541A00	10	36~39	B2415210000	24	46	B2526220000	30	10
B1905541B00	10	36~39	B24152800A0	20	62	B2527210000	28	15
B1905541C00	10	36~39	B2416280000	20	61	B2529220A00	30	21
B1905541D00	10	36~39	B2417280000	20	64	B2529220ABA	30	15
B2101220000	22	33	B2418280000	20	60	B2529220ABB	30	20
B21012200A0	22	18	B24212050A0	20	59	B2531220000	30	4
B2102205000	22	22	B242328000A	20	65~67	B2532220000	30	5
B2103220000	22	34	B242328000B	20	65~67	B2533220000	30	6

NUMERICAL INDEX OF PARTS

PART NO	PAGE	REF NO.	PART NO	PAGE	REF NO.	PART NO	PAGE	REF NO.
B2535220000	28	27	B2582220000	62	12	B3206210000	2	13
B25372200A0	30	34	B25822200A0	62	11	B3207210000	2	14
B2538220A00	30	35	B2583220000	62	16	B3208210000	2	15
B2540205B00	28	33	B2584220000	62	17	B3208280000	2	26
B2540205B00	30	13	B2585220000	62	25	B3209210000	2	16
B2550220000	32	3	B2586220000	62	26	B3210210000	2	17
B25502200A0	32	2	B2587220000	62	29	B3211210000	2	18
B2551220000	32	5	B2588220000	62	30	B3212210000	2	19
B2552220000	32	13	B2589210000	62	18	B3212761000	2	20
B2553220000	32	15	B2589220000	62	28	B3213205000	10	44
B25532200A0	32	14	B2591220000	60	5	B3311012000	48	8
B25532200Y0	62	7	B259122000B	62	10	B3317704000	48	10
B2554220000	32	28	B2592220000	32	20	B3319704L00	48	12
B2555220000	32	29	B2593220000	62	6	B3320704L00A	48	13
B2556220000	32	1	B2594220000	62	31	B3501210000	36	31
B25562200Y0	62	9	B2595210000	62	13	B3502220000	36	1
B25562200YB	62	8	B259522000A	62	33	B3504220000	36	10
B2557220000	60	2	B259522000B	62	34·41	B3504280000	38	55
B255728000A	34	63~67	B259522000C	62	34·41	B3505019000	44	47
B255728000B	34	63~67	B2596210000	62	14	B3505210000	36	11
B255728000C	34	63~67	B2597210000	62	15	B3505280000	38	54
B255728000D	34	63~67	B2629980000	46	48	B3506210000	36	15
B255728000E	28	36	B2702210000	22	17	B3507210000	36	32
B255728000E	34	63~67	B2703210000	40	44	B3507220000	36	20
B2558220000	32	16	B2714761000	24	10	B3507280000	36	6
B2559220000	60	3	B2727761000	24	11	B3508220000	36	21
B2560220000	32	17	B31012800A0	60	8	B3508280000	36	35
B2561220000	32	18	B3107804000	22	7	B3509220000	36	2
B2562220000	32	30	B3112761000	22	5·6	B3509280000	36	16
B256322400B	32	31	B3114232000	22	11·12	B35142100A0	10	10
B2564220000	32	19	B3114771000	2	45	B3518210000	36	33
B2565220000	32	6	B3120125000	22	9	B3518280000	36	17
B2566220000	32	32	B3123352000	2	78	B3520220000	36	22
B2567220000	32	7	B3123352000	4	78	B3522220000	36	30
B2568220000	32	33	B3125012000	2	79	B3523220000	36	8
B2569220000	32	8	B3125012000	4	79	B3538112000	36	36
B2570220000	32	34	B3126012000	2	76	B4004220000	40	5
B2572220000	32	9	B3126012000	4	76	B40042200A0	40	4
B25722200A0	32	4	B3126012000	22	10	B4005220000	40	11
B2573220000	32	35	B3129053000	22	11·12	B40052200A0	40	10
B2574220000	32	36	B3132552000	22	13	B4006220000	40	12
B2576220000	32	37	B32012100A0	2	9	B4007220000	28	28
B2578220000	32	38	B3203210000	2	10	B4008220000	40	1
B2580220000	32	39	B3204210000	2	11	B40092200A0	40	2
B2581220000	62	27	B3205210000	2	12	B4010220000	40	3

NUMERICAL INDEX OF PARTS

PART NO	PAGE	REF NO.	PART NO	PAGE	REF NO.	PART NO	PAGE	REF NO.
B4011210000	40	22	B8306220000	44	18	HC018801030	54	9
B4012220000	40	20	B8307220000	44	19	HC018803320	54	7
B40122200A0	40	19	B8308220000	44	20	HC034205620	54	8
B41102200AA	40	34	B8309220000	44	22	HD000120000	40	13
B41302200A0	40	35	B8601WP10A0	60	11	HF001400700	58	11
B471022000A	42	1	B9101552000	60	10	HG003270000	54	18
B471022000B	42	2	B9121012000	46	72	HG003280000	52	4
B471022000C	32	41	B91212200A0	60	1	HG003290000	52	6
B471022000D	14	23	BP300000000	36	58	HK018800020	22	32
B471122000A	14	26	BP300000000	38	58	HK045550060	56	32-33
B471122000B	14	27	BP500000000	36	29	HK045550080	56	32-33
B471122000C	32	46	BP600000000	36	7	HL006390000	54	32
B471122000D	32	47	BT0600401EB	42	22	HL014530001	54	2
B471122000G	34	48	CQ202000000	36	24	HM000630010	50	12
B471122000H	34	49	CQ252200000	36	57	HP000200200	22	31
B47152200A0	42	3	CQ252200000	38	57	HP001420000	40	43
B810322000B	44	21	CS079101FSH	20	52	HT002460000	54	17
B8108220000	44	23	CS080081FSH	20	53	HT002570000	54	31
B8109220000	44	24	CS1111101CSH	14	47	HT003330000	54	22
B8110220000	44	39	CS1470710SH	12	58	HX000210000	50	20
B81102200A0	44	38	CS147121ESH	10	15	HX000220000	42	23
B8111220000	44	40	D1455055B00	14	31	HX00093000C	40	37
B8112220000	44	41	D1456055B00	14	32	HX00114000B	50	19
B8150220000	44	25	D1457055B00	14	33	HX00123000A	40	36
B8160220000	44	1	D1805MLBH00	18	5	HX001530000	52	5
B8161220000	44	2	D2112555B00	36	37	HX001970000	54	33
B8162220000	44	3	D2430555B00	2	21	HX002330000	34	50
B8163220000	44	4	D2430555B00	24	34	HX002330000	40	38
B8164220000	44	6	D3112L4BB00	22	5-6	HX00269000A	56	23
B81642200A0	44	5	D3310555D00	48	14	HX002920000	56	36
B8165220000	44	7	D6028555B0B	30	24	HX002980000	50	15
B8166220000	44	8	D6042555B00	30	23	HX00326000B	46	71
B8171220000	44	10	D8604761C0B	30	19	HX00326000F	56	37
B8173220000	44	11	E8523304000	58	13	HX003290000	34	68
B820122000EA	44	44	E8760452M00	30	22	HX00339000C	54	25
B820122000FA	44	45	E9611601000	58	12	HX004070000	56	39
B8202205000	44	42	E9628252000	54	23	HX004140000	54	3
B821021000B	46	77	E9628252000	58	10	HX004150000	56	16
B821121000B	46	75	EA9500B0100	42	20	M1001518000	50	6
B8301220000	44	13	EA9502B0500	42	21	M10025130AA	50	8
B83012200A0	44	12	G5430116000	42	5	M1003518000	54	14
B8302220000	44	14	GBR01713000	54	10	M1005518000	54	15
B8303220000	44	15	HA001410000	52	7	M1010510000	50	21
B8304220000	44	16	HC010802210	54	5	M1011512000	50	17
B8305220000	44	17	HC018701020	54	6	M1021512000	54	28

NUMERICAL INDEX OF PARTS

PART NO	PAGE	REF NO.	PART NO	PAGE	REF NO.	PART NO	PAGE	REF NO.
M1075518000	52	16	M8601518AA0	56	1	NS6110530SP	2	27
M1076510000	52	13	M86025120A0	54	27	NS6110530SP	14	37
M1077510000	52	14	M86025120A0	56	8	NS6120310SP	24	36
M1078510000	52	15	M86035180A0	56	18	NS6150310SP	4	65
M1081518000	52	9	M8603518AA0	54	13	NS6150430SP	14	38
M1082518000	52	20	M86045180A0	54	4	NS6240630SN	46	53
M300451100B	58	9	M86045180A0	56	22	NS6660430SP	20	51
M300451300G	52	10·11	M86065100A0	40	21	PA1601506A0	14	24
M30045180A0	58	21	M8670510AA0	52	3	PA1602503A0	32	42
M3010110B00	58	3	M90415180A0	56	35	PA1602504A0	32	43
M3010518000	52	10·11	M90425180A0	56	15	PA1603003A0	16	53
M40051100A0	10	3	M90435180A0	56	13	PC010508000	14	25
M40071100AB	10	18	M90445180A0	56	14	PC012401000	42	16
M8510518AA0A	50	1~5	M90505180A0	52	8	PF0552040B0	42	6
M8510518BA0A	50	1~5	M90505180A0	56	17	PF065206000	42	7
M8510518CA0A	50	1~5	M9609171000	54	20	PF070501000	42	17
M8510518DA0A	50	1~5	M9650513000	58	14	PJ030520001	42	8
M8510518EA0A	50	1~5	MAO11532000	48	17	PJ032052503	42	13
M85115120A0	56	4·5	MAT80116S00	46	66	PJ046052503	32	44
M8513518AA0	56	25~27	MC200501000	12	59~62	PJ304065101	42	12
M8513518BA0	56	25~27	MC372001100	12	59~62	PJ305065202	42	9
M8513518CA0	56	25~27	MDP170B1800	12	59~62	PJ308040002	42	14
M85145120A0	56	29	MDP500B1400	12	59~62	PJ309005203	42	4
M85315180A0	50	11	MTJVM004700	58	19	PJ309120001	60	6
M85325180A0	50	10	MTJVM004800	58	20	PS0150065KP	2	23
M85435120A0	56	21	MTSP00800A0	58	16	PS0250162KH	20	54
M85465120A0	56	6	MTSP00950A0	58	15	PS0400141KH	46	63
M85475120A0	56	7	NM60300000A	62	22	PS0800302KH	2	35
M85515120A0	56	12	NM6030001SC	40	18	PV0351130A0	42	15
M85525120A0	56	24	NM6030001SC	52	18	PX950009000	42	10
M85545120A0	56	3	NM6030001SC	54	35	RE0300000K0	14	34
M85555120A0	56	20	NM6040001SB	50	24	RE0300000K0	34	61
M85565120A0	56	10	NM6040003SC	22	30	RE0600000K0	28	34
M85575120A0	56	11	NM6040003SC	24	24	RE0600000K0	30	12
M8561510CA0	56	31	NM6050001SE	28	37	RE0600000K0	34	62
M85615120A0	56	42	NM6050001SE	48	16	RO048190100	14	35
M8570518AA0	52	1·2	NM6060002SE	46	56	SB108000500	28	29
M8570518BA0	52	1·2	NM6080001SC	44	36	SB108000500	30	11
M85715180A0	52	12	NM6120011SF	8	25	SB712000100	28	35
M85785180A0	50	13	NM6550815SF	58	18	SD0500803TP	24	37
M85905130AA	58	1	NS6090310SP	4	64	SD0530221SP	24	16
M85925120A0	56	41	NS6110310SP	2	29	SD0600101TP	20	72
M85995120A0	58	2	NS6110310SP	28	20	SD0600352SP	22	25
M85995120AB	58	8	NS6110360SP	32	25	SD0640321SP	14	55
M8601518AA0	54	1	NS6110420SP	24	35	SD0640321SP	16	55

NUMERICAL INDEX OF PARTS

PART NO	PAGE	REF NO.	PART NO	PAGE	REF NO.	PART NO	PAGE	REF NO.
SD0640321SP	22	27	SM8061002TP	30	37	SS6151812TP	28	32
SD0640321SP	24	17	SM9061850SC	46	65	SS6621220SP	22	24
SD0640321TP	14	45	SM9087533SC	44	9	SS6681712TP	10	14
SD0650305TP	24	38	SM9122503SB	44	28	SS7080510TP	12	51
SD0720321TP	14	46	SM9124503SB	8	18	SS7090410SP	20	70
SD0800341SP	46	67	SS1060210TP	20	68	SS7090530SP	32	11
SD0801021TP	20	48	SS1090510SP	60	4	SS7090620TP	24	15
SD1100301TP	24	47	SS1110640TP	18	2	SS7090850SP	40	40
SK3381300SC	46	69	SS1110840SP	6	10	SS7091110SP	14	40
SL4030681SC	52	21	SS1110840SP	32	23	SS7110510SP	18	43
SL4030691SC	50	16	SS2110920TP	26	49	SS7110510SP	40	26
SL4030881SC	54	11	SS2122410TP	34	51	SS7110710SP	18	44
SL4030891SC	56	9	SS3090610SP	4	50	SS7110710SP	36	50
SL4031281SC	54	34	SS4090715SP	4	51	SS7110710SP	38	50
SL4031481SC	44	43	SS4110515SP	4	52	SS7110710SP	40	39
SL4031481SC	54	21	SS4110515SP	32	21	SS7110740TP	20	71
SL4031481SF	40	14	SS4110715SP	8	14	SS7110840SP	4	58
SL4040691SC	46	76	SS4110815SP	4	54	SS7110840SP	18	45
SL4040881SF	56	19	SS4110815SP	40	42	SS7110840SP	22	35
SL4040891SC	42	19	SS4111015SP	4	56	SS7110840SP	24	26
SL4041091SC	46	52	SS4111015SP	8	15	SS7110840SP	30	31
SL4041091SC	50	22	SS4150715SP	4	57	SS7110840SP	38	49
SL4041091SC	56	40	SS6060410TP	18	38	SS7110840SP	40	29
SL4042091SC	56	34	SS6090440SP	38	56	SS7110910TP	28	18
SL4042581SF	42	18	SS6090630TP	22	23	SS7111110TP	18	46
SL4051091SC	42	11	SS6090670TP	12	50	SS7111110TP	28	16
SL4051091SC	56	28	SS6092120SP	36	40	SS7111410TP	14	41
SL4051241SE	46	73	SS6110430TP	20	69	SS7121610SP	30	26
SL9082093SE	44	35	SS6110610TP	6	11	SS7151120SP	12	49
SL9082093SE	50	7	SS6110610TP	28	31	SS7151210SP	30	27
SM1030601SC	62	21	SS6111140SP	36	41	SS7151610SP	34	52
SM1031001SC	62	20	SS6111210SP	10	21	SS7152040SP	30	28
SM1046051SF	50	14	SS6111610SP	34	55	SS7661540SP	14	42
SM4040601SC	4	59~62	SS6120940SP	34	54	SS8090410SP	4	68
SM4051405SE	48	18	SS6121210SP	24	43	SS8090610SP	22	14
SM5030655SP	62	19	SS6121210SP	28	38	SS8110422TP	10	6
SM5051400SC	8	17	SS6121212TP	18	39	SS8110422TP	32	24
SM5051400SC	44	27	SS6121220TP	24	9	SS8110520TP	2	24
SM6031010SC	40	23	SS6122510SP	10	12	SS8110560SP	4	67
SM6040552TP	28	30	SS6150710SP	14	39	SS8111010TP	10	5
SM6040602TP	32	12	SS6151220SP	18	41	SS8111610SP	10	45
SM6041402TP	28	19	SS6151412TP	10	13	SS8120410SP	34	56
SM6051602TP	28	40	SS6151712TP	24	14	SS8120740SP	30	29
SM6053002UZ	28	39	SS6151712TP	40	25	SS8120740SP	34	53
SM6061610SC	48	19	SS6151812TP	22	16	SS8150822TP	18	47

NUMERICAL INDEX OF PARTS

PART NO	PAGE	REF NO.	PART NO	PAGE	REF NO.
SS8150822TP	30	36	WP0612066SP	14	36
SS8151550SP	10	20	WP0621016SD	6	14
SS8660610TP	12	53	WP0621016SD	30	33
SS8660610TP	14	43	WP0621016SD	34	71
SS8661012TP	12	57	WP0621016SD	38	51
SS9090833TP	12	55	WP0641600SC	34	72
SS9111010SP	28	17	WP0641601SC	46	58
SS9111020TP	2	22	WP0651056SH	2	25
SS9150710TP	34	69	WP0820526SD	30	14
SS9151120CP	6	16	WP0841600SE	46	61
SS9151120CP	46	68	WP0841601SC	8	22
SS9151160CP	6	12	WP0841601SC	44	60
SS9151240SN	8	16	WP0841601SC	46	60
SS9151440CP	30	30	WP0952616SD	20	50
SS9151440CP	62	32	WP1021016SD	46	59
SS9152130CP	34	70	WP1302501SC	44	31
SS9661230CP	12	52	WP1302501SE	8	23
TA0750704R0	4	70	WP1702600S0	48	20
TA0850604R0	4	71	WS0310002KN	62	24
TA1050504R0	4	72	WS0410002KN	50	23
TA1250406R0	4	73	WS0510002KN	48	21
TA2100904R0	4	74	WS0610002KN	46	62
WP0320500SC	52	19	WS0631510KP	34	73
WP0320501SC	62	23	WS0820002KN	46	70
WP0330501SB	40	24	WS1002560KR	58	17
WP0371016SD	22	28	WS1253010KN	8	24
WP0430801SC	4	59~62	WS1253010KN	44	34
WP0450000SD	4	59~62	WS1643202KR	48	22
WP0450000SD	32	59			
WP0450000SD	34	59			
WP0450000SD	38	52			
WP0450801SD	8	21			
WP0450801SD	10	22			
WP0450801SD	40	33			
WP0450846SP	20	73			
WP0482086SD	54	26			
WP0501016SD	24	39			
WP0501016SD	30	32			
WP0501016SD	32	26			
WP0520656SA	6	13			
WP0520656SA	34	58			
WP0531000SD	20	49			
WP0561616SC	22	29			
WP0561616SC	44	74			
WP0561616SC	46	74			